



JVC

ENGLISH

JVC

InteriArt

LT-17D50BK

LT-23D50BK

INTEGRATED DIGITAL WIDE LCD PANEL TV

INSTRUCTIONS



50060737

0205MKH-VT-VT



DVB
Digital Video
Broadcasting

*Trade Mark of the DVB Digital Video Broadcasting
Project (1991 to 1996) Number: 3465*

Contents

For your safety	2	Analogue Teletext	37
Important Instruction	4	Peripheral Equipment Connections	39
Where to install	5	Peripheral Equipment Connections	42
Distance Recommendation	5	Antenna Connections	43
Important Information	6	Peripheral Equipment Connections	43
Control Panel Buttons	7	PC Input Typical Display Modes	44
Using the stand	8	Tips	46
Remote Control Buttons	9	Specifications	47
Features	10		
Getting Started	11		
T-V LINK	15		
Basic Operations	16		
Operating while watching IDTV	17		
Everyday Operation	17		
Digital Teletext	19		
DTV Menus	19		
Timers (DTV Timer Recording)	20		
Configuration	22		
Edit PR List	23		
Installation	25		
Common Interface	26		
Setting The TV	27		
Menu System	27		
Picture Menu	27		
Sound Menu	29		
Feature Menu	30		
Install Menu	30		
Program Menu	32		
Source Menu	33		
Other Features	33		
PC Mode	35		
Installation	35		
Main Menu in PC mode:	35		
PC Picture Position Menu:	35		
PC Picture Menu	36		
Sound Menu	36		
PIP Picture	36		
Source Menu	37		
Sound in PC mode	37		

For users in the UK:

If you have any problems setting up your new TV, please call the **JVC** Helpline on 0870330 5000

For users in the Republic of Ireland:

If you have any problems setting up your new TV, please call the **JVC** Helpline on 1890 - 582500

For your safety

This equipment has been designed and manufactured to meet international safety standards but, like any electrical equipment, care must be taken if you are to obtain the best results and safety is to be assured. So, please read the points below for your own safety. They are of a general nature, intended to help you with all your electronic consumer products and some points may not apply to the goods you have just purchased.

Some “DOs” and “DON'Ts” for you

Air Circulation...

Leave at least 10cm clearance around the television to allow adequate ventilation. This will prevent the TV from overheating and consequential possible damage to the TV. Dusty places should also be avoided.

Heat Damage...

Damage may occur if you leave the TV in direct sunlight or near a heater. Avoid places subject to extremely high temperatures or humidity, or locations where the temperature is likely to fall below 5°C (41°F).

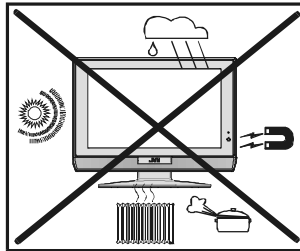

Mains Supply...

The mains supply required for this equipment is **100 -240 AC, 50 Hz**. Never connect to a DC supply or any other power source. DO ensure that the TV is not standing on the mains lead. DO NOT cut off the mains plug from this equipment, this incorporates a special Radio Interference Filter, the removal of which will impair its performance.

Hot / Moderate Climate Conditions

This device is suitable for working in hot and moderate climate conditions.

IF IN DOUBT PLEASE CONSULT A COMPETENT ELECTRICIAN.

DO...

DO read the operating instructions before you attempt to use the equipment.

DO ensure that all electrical connections (including the mains plug, extension leads and inter-connections between pieces of equipment) are properly made and in accordance with the manufacturers' instructions.

Switch off and withdraw the mains plug before making or changing connections.

DO consult your dealer if you are ever in doubt about the installation, operation or safety of your equipment.

DO be careful with glass panels or doors on equipment.

DO NOT...

DON'T remove any fixed cover as this may expose dangerous voltages.

DON'T obstruct the ventilation openings of the equipment with items such as newspapers, table-cloths, curtains etc. Overheating will cause damage and shorten the life of the equipment.

DON'T allow electrical equipment to be exposed to dripping or splashing or objects filled with liquids, such as vases, to be placed on the equipment.

DON'T place hot objects or naked flame sources, such as lighted candles or night-lights on, or close to the equipment. High temperatures can melt plastic and lead to fires.

DON'T use makeshift stands and NEVER fix legs with wood screws. To ensure complete safety, always fit the manufacturer's approved stand or legs with the fixings provided according to the instructions.

DON'T listen to headphones at high volume, as such use can permanently damage your hearing.

DON'T leave equipment switched on when it is unattended, unless it is specifically stated that it is designed for unattended operation or has a standby mode. Switch off using the switch on the equipment and make sure your family know how to do this. Special arrangements may need to be made for infirm or handicapped people.

DON'T continue to operate the equipment if you are in any doubt about it working normally, or it is damaged in any way – switch off, withdraw the mains plug and consult your dealer.

DON'T put the empty batteries into garbage instead of recycle bin to reduce harmful effects to the environment.

ABOVE ALL – NEVER let anyone, especially children, push anything into holes, slots or any other openings in the case – this could result in a fatal electric shock.

NEVER guess or take chances with electrical equipment of any kind – it is better to be safe than sorry.

To fully disconnect the TV, switch off the mains socket and remove the Power plug.

Safety Precautions for Power adapter

- Be careful! May become hot.
- For indoor and dry location use only.
- Risk of electric shock.
- Shock hazard, do not open.
- Keep all power adapters away from any other heat source.
- Always use power adapter(s) well-ventilated area.

*** Cold cathode fluorescent lamp in LCD PANEL contains a small amount of mercury, please follow local ordinances or regulations for disposal.*

"The LCD panel is very high technology product with about a million thin film transistors, giving you fine picture details. Occasionally, a few non-active pixels may appear on the screen as a fixed point of blue, green or red. Please note that this does not affect the performance of your product." Please note that certain light guns used with games consoles may not work on this product.

Warning:

This is a Class A product. In a domestic environment this product may cause radio interference in which case the user may be required to take adequate measures.

WARNING

- Fingers may be trapped under the TV causing injuries. Hold the TV at the bottom in the middle, and do not allow it to tilt up or down.
- The TV may fall causing injuries. Hold the bottom of the stand with your hand and tilt the TV up and down.
- Do not allow children to hang from the TV, place their elbows on the TV or lean against the TV. Doing so may cause the TV to fall over and lead to injuries.

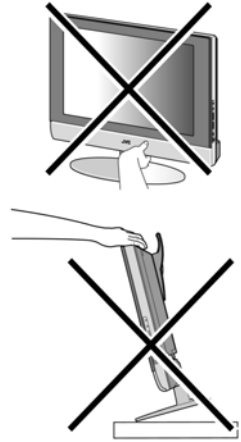

CAUTION:

- To avoid electric shock or damage to the unit, first firmly insert the small end of the power cord into the AC Adapter unit it is no longer wobbly, and then plug the larger end of power cord into an AC outlet.

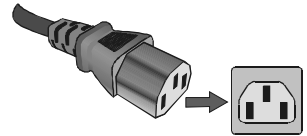

Important Instruction

For your own safety read following instruction carefully before attempting to connect this unit to the mains supply.

MAINS (AC) OPERATION

The wires in this mains lead are coloured in accordance with the following code :

BLUE-NEUTRAL

BROWN-LIVE

As the colours of the wires in the mains lead of this appliance may not correspond with the coloured markings identifying the terminals in your plug, proceed as follows:

The wire which is coloured blue must be connected to the terminal which is marked with the letter N or coloured black.

The wire which is coloured brown must be connected to the terminal which is marked with the letter L or coloured red.

No connection is to be made to the earth terminal of the plug.

If a 13 Amp (BS 1363) Plug is used a 5 Amp Fuse must be fitted, or if any other type of Plug is used a 5 Amp Fuse must be fitted, either in the Plug of Adaptor, or on the Distribution Board.

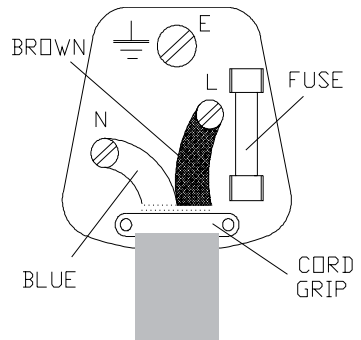

CAUTION

TO PREVENT ELECTRIC SHOCK DISCONNECT FROM THE MAINS BEFORE REMOVING COVER. NO USER SERVICEABLE PARTS INSIDE. REFER SERVICING TO QUALIFIED SERVICE PERSONNEL.

SAFETY PRECAUTION

THIS EQUIPMENT MUST BE DISCONNECTED FROM THE MAINS WHEN NOT IN USE. DO NOT ALLOW THIS UNIT TO BE EXPOSED TO RAIN OR MOISTURE.

Where to install

WARNING

- When you install the TV on the wall, only use a JVC wall mounting unit (optional) which is designed for this TV.
- Make sure the TV is installed on the wall by a skilled installer.

Locate the TV away from direct sunlight and strong lights, soft, indirect lighting is recommended for comfortable viewing. Place on a sturdy platform, the mounting surface should be flat and steady, it should then be secured to the wall with a sturdy tie using the hook on the back of the TV, this will prevent it from falling over. Use curtains or blinds to prevent direct sunlight falling on the screen.

A floor and table top stand are available for this television, or an angled bracket which enables the TV to be wall-mounted.

The LCD display panels are manufactured using an extremely high level of precision technology, however sometimes some parts of the screen may be missing picture elements or have luminous spots. This is not a sign of a malfunction.

Make sure the TV is located in a position where it cannot be pushed or hit by objects, as pressure will break or damage the screen.

Distance Recommendation

Install the TV on solid horizontal surface such as a table or desk.

For ventilation, leave a space of at least 10 cm free all around the set. To prevent any fault and unsafe situations, please do not place any objects on top of the set.

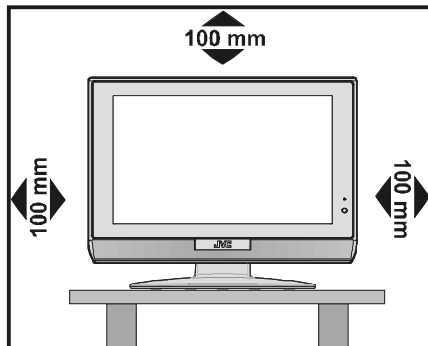

Important Information

Please take note

EXCLUSION CLAUSE

JVC shall under no circumstances be liable for loss and/or damage to the product caused by:

- fire;
- earthquake;
- accidental damage;
- intentional misuse of the product;
- use of the product in improper conditions;
- loss and/or damage caused to the product whilst in the possession of a third party;
- any damage or loss caused as a result of the owner's failure and/or neglect to follow the instructions set out in the owner's manual;
- any loss or damage caused directly as a result of misuse or malfunction of the product when used simultaneously with associated equipment;

Furthermore, under no circumstances shall **JVC** be liable for any consequential loss and/or damage including but not limited to the following, loss of profit, interruption of business, the loss of recorded data whether caused during normal operation or misuse of the product.

WARNING! NEVER LEAVE A STATIONARY IMAGE ON THE SCREEN

If stationary images generated by TELE-TEXT, CHANNEL IDENTIFICATION LOGOS, COMPUTER DISPLAYS, VIDEO GAMES, ON SCREEN MENUS, etc. are left on the TV screen for any length of time, they could become permanently ingrained.

If you use your television to display completely still images, or moving pictures which have a permanent still image superimposed e.g. broadcast network logos, it is always advisable to reduce BOTH the brightness and contrast settings.

Care and disposal

Cleaning the screen and cabinet...

Turn off the power, clean the screen and cabinet with a soft, dry cloth. We recommend that you do not use any proprietary polishes or solvents on the screen or cabinet as this may cause damage.

Disposal...

When the set reaches the end of its useful life please dispose of it in accordance with Local Government Regulations or at a recycling centre.

Control Panel Buttons

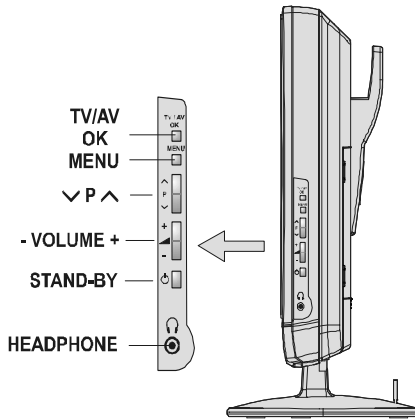
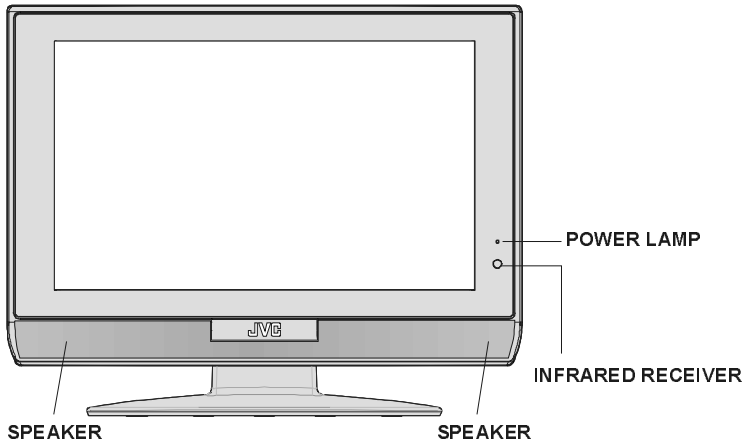

Using the stand

This TV comes with a Table Top Stand already attached.

This stand can be used to adjust the direction of the TV screen 10° backward and 5° forward.

Tilt the TV up and down:

While holding the bottom of the stand with one hand, use your other hand to hold the middle of the top of the TV and slowly tilt the TV up and down.

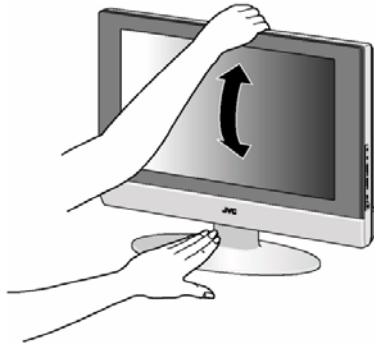

Remote Control Buttons

- ① = (Stand By) button
- ② TV / VCR / DVD Switch
- ③ Number buttons
- ④ **AV** button
(EXT-1,EXT-2,EXT-3,EXT-4,
S-VIDEO, PC, DIGITAL)
- ⑤ Colour button
- ⑥ **MENU** = Menu button
- ⑦ = Cursor Up button
- ⑧ **OK** button
- ⑨ = Cursor Right button
- ⑩ **BACK** = Back button
- ⑪ = Volume -/+ buttons
- ⑫ **GUIDE** button
- ⑬ **SUBTITLE** button
- ⑭ PC Control buttons
- ⑮ = Hyper Sound On/Off button
- ⑯ **ZOOM** = Zoom button
- ⑰ \wedge/\vee buttons
- ⑱ **IDTV / VCR / DVD / Teletext Control buttons**
- ⑲ $P\wedge/\vee$ buttons
- ⑳ = Cursor Down button
- ㉑ = Teletext button
- ㉒ = Cursor Left button
- ㉓ **TV / DTV** button
- ㉔ = Information Button / T-V Link in Program Menu
- ㉕ = Mute button

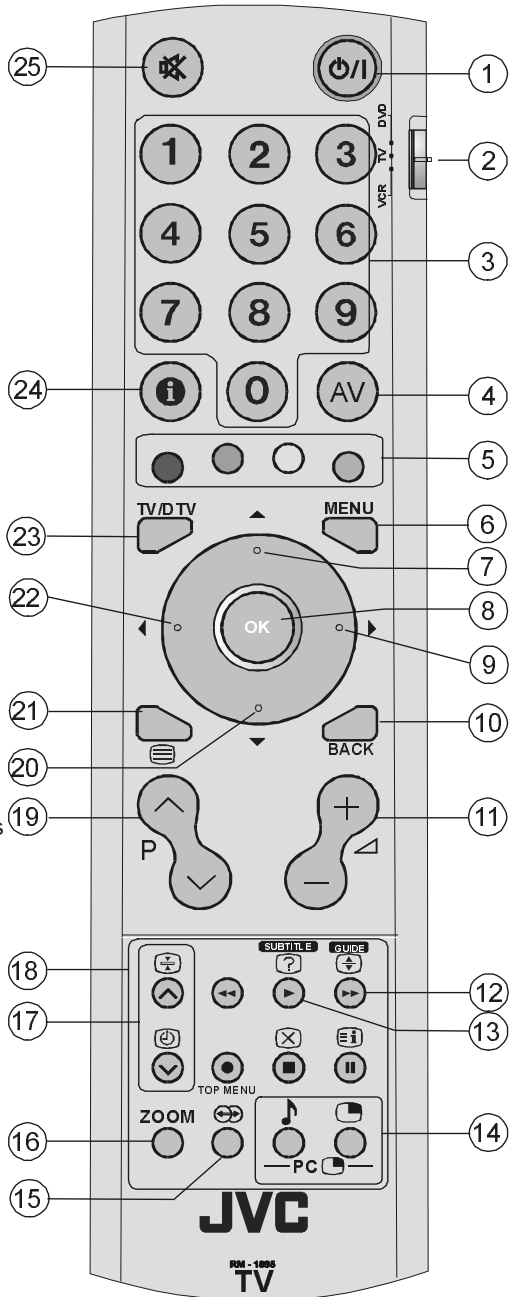

Features

- It is a remote controlled **Integrated Digital** colour television and PC monitor.
- 100 programmes from VHF, UHF bands or cable channels can be preset.
- It can tune cable channels.
- Controlling the TV is very easy by its menu driven system.
- It has 2 pieces of Euroconnector socket for external devices (such as video, video games, audio set, etc.)
- To use as a PC monitor, 15 Pin Mini D-Sub connector for computer.
- Optional stereo sound systems (German or German+Nicam) are available.
- Multilanguage OSD.
- Teletext (Fastext, 7 pages).
- It is possible to connect headphone.
- A.P.S. (Automatic programming system)
- All programmes can be named.
- Forward or backward automatic tuning.
- Sleep timer.
- Child lock.
- Auto, Full, Regular, Panoramic, 14:9 Zoom, 16:9 Zoom, 16:9 Zoom Subtitle modes.
- Automatic sound mute when no transmission.
- When no valid signal is detected, after 5 minutes the TV switches itself automatically to stand-by mode.
- NTSC Playback.
- Universal power supply range is a standard feature on this model.
- TV Picture in PC (if PC input available).
- PLL (Channel Search)
- PC input (Support Up to 1280 x 768)*
 - * Support up to 1360x768 for Model 23D50BK.

Getting Started

Follow Step 1 to 7 to set up your TV:

Step 1: Checking the accessories supplied

- Remote control unit x 1
- AA/R6 battery x 2
- AC adapter x 1
- Power cord x 1

Step 2: Inserting batteries

- Remove the battery cover located on the back of the remote control by gently pulling upwards from the indicated part.
- Insert two AA/R6 dry cell or equivalent type of batteries inside.
- Replace the battery cover.

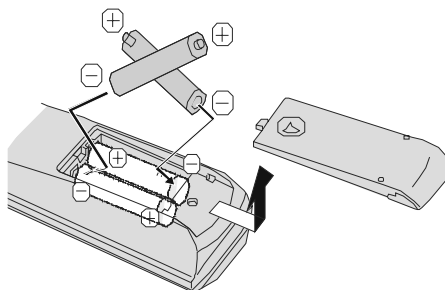

NOTE: Remove the batteries from remote control when it is not to be used for a long period. Otherwise it can be damaged due to any leakage of battery.

Old batteries must be disposed in a designated area. If performance of the remote control reduces, replace the batteries with the correct type. Do not combine a used, old battery or a new one or mixed battery types. Remove dead batteries immediately to prevent acid from leaking into the battery compartment.

Step 3: Removing the terminal cover

There are connection terminals and a card socket behind the covers of the rear of the TV. Remove the cover before connecting an antenna, VCR, DVD and other devices.

Remove the covers by removing the hooks. When replacing the covers, place the side or bottom of the covers against the TV and insert the hooks.

- Leave the covers off if they do not fit properly. DO NOT force to replace the covers. Doing so may cause damages of the connection cables and the covers.
- Leave these covers off when mounting the TV on a wall.

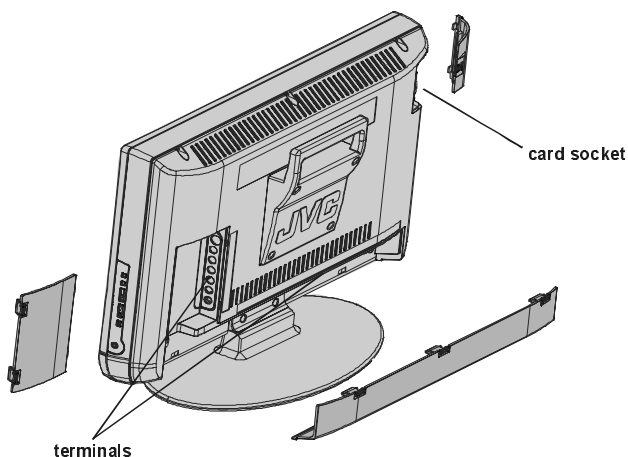

- 100 mm mount based on VESA regulation is equipped.
- The handle and the stand can be left by loosening the screws with a screwdriver when mounting the TV on a wall.
- Spread a soft cloth on a flat table and then place the TV on the cloth with the screen facing downwards when you leave the handle and the stand.

Step 4: Connecting an aerial VCR and mains

Please read the user manual of each device before connecting, to ensure a correct setup.

It is necessary to connect aerial to watch TV.

Please see “Peripheral Equipment Connections” on page 39 for connections to other devices.

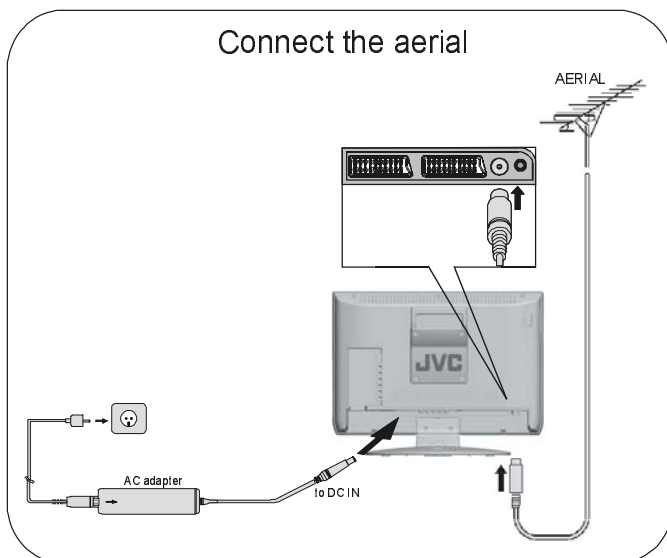

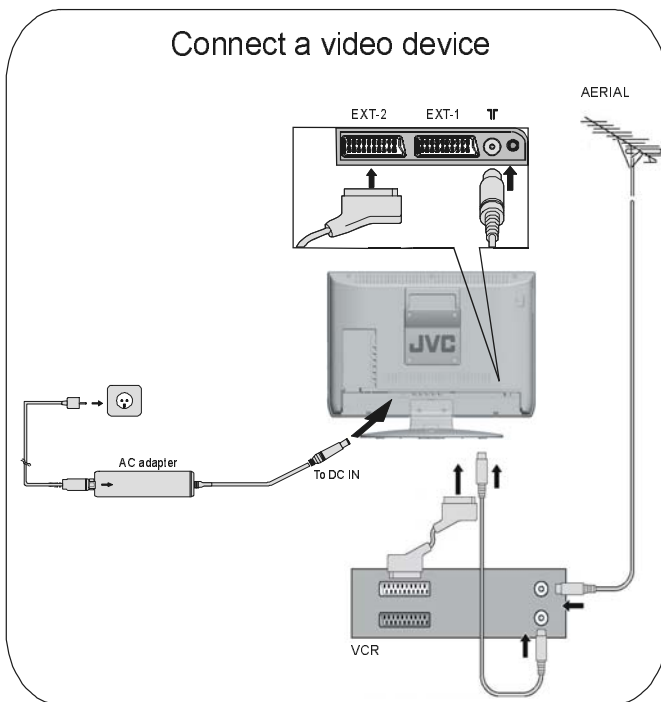

IMPORTANT:

- Only use the adaptor supplied with this TV.
- Model 17D50BK: The TV set is designed to operate on 12 V DC. For this, an adaptor is used which gives 12 V DC voltage. Connect this adaptor to a system that supplies 100-240 V AC, 50 Hz.
- Model 23D50BK: The TV set is designed to operate on 24 V DC. For this, an adaptor is used which gives 24 V DC voltage. Connect this adaptor to a system that supplies 100-240 V AC, 50 Hz.

Step 5: Using the cable holder

A cable holder which is used to keep the connection cables tidy is supplied. Attach the cable holder to the hole on the back of the stand, then gather together the connection cables and put them inside the holder.

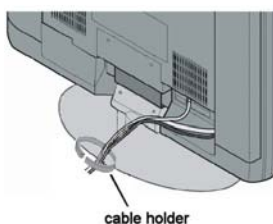

Step 6: Switching the TV ON/OFF

To switch the TV on

Your TV will switch on by two steps:



- 1- Connect the power supply cord to the system. Then the TV switches itself to stand-by mode and the power lamp becomes red located on the front of the TV.
- 2- To switch on the TV from stand-by mode either:

Press the “ / |” button on the remote control or on the right side of the TV

or,

press a digit button on the remote control so that a programme number is selected,

or,

Press “” or “” buttons on the right side of the TV or on the remote control, so that last switched off programme is selected.

By either ways the TV will switch on and the power lamp will become green.

To switch the TV off

- Press the “ / |” button on the remote control or on the right side of the TV, so the TV will switch to stand-by mode and the power lamp will become red.

NOTE: To switch the TV off completely remove the mains plug from the socket.

Step 7: Initial settings

When the TV is first turned on, it goes into the initial settings mode. Follow the instructions on the screen display to make the initial settings.

Note: If the TV does not go into the initial settings mode this is because your TV has already been turned on for the first time. (Perform the initial settings with “INSTALLATION” (see page 25) in the DTV menu and “AUTO STORE” (Analogue) (see page 32) in the PROGRAM menu.)

Because this is the first time that IDTV has been used, there are no channels stored in the memory and below information will be displayed on the screen.

1. Press the [OK] button to start the automatic search.

PR List Empty. Start automatic search.

OK

The IDTV will automatically tune to the UHF transmission channels 21 to 68 looking for digital terrestrial TV broadcasts and displaying the names of channels found. This process will take about five minutes. To cancel searching, you can press MENU button at any time during the process.

HINT: Depending on the reception conditions in your particular area, you may find that the list of channels found includes one or more repeated names. This is because the receiver may detect and store some channels, including those it cannot receive clearly, from adjacent areas alongside the strong channels from a transmitter nearby. This is not a problem and the weaker channels can be deleted from the receiver later, as described in - Edit PR List on page 23.

If no digital terrestrial television broadcasts are found, the receiver will display a message:

No programme found.
Please check antenna signal.

OK

When “OK” button is pressed, following message will appear on the right bottom of the screen:

PR List Empty

2. When the automatic search has finished, the EDIT PR LIST menu appears.

- If you want to, you can now edit the programme numbers (PR) using the EDIT PR LIST function. For details, see “Edit PR List” on page 23.
- If you do not want to edit programme numbers (PR), go to the next step.

3. Press the MENU button.

The EDIT PR LIST menu disappears and the following message appears.

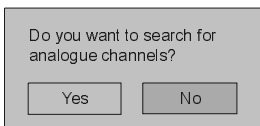

If you select “Yes”, Analogue terrestrial broadcasting AUTOMATIC PROGRAMMING SYSTEM (A.P.S.) window is displayed.

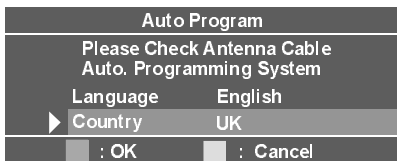

To cancel APS before starting, press BLUE button.

First of all choose the “**Language**” which the menus of the analogue part of the TV will appear. As soon as you change the language, the menu items will be displayed in the selected language. . By pressing the “▲” or “▼” button, come to the “**Country**” item and select the country. This will effect the sort process in APS. Press RED button to start A.P.S.

After APS is finalized, a programme list will appear on the screen. In the programme list you will see the programme numbers and names assigned to the programmes.

If you press the BLUE button at any time while the A.P.S. is running, the A.P.S. will be ended.

If you do not accept the locations and / or the programme names of programmes, you can change them in Program menu. For details see PROGRAM menu on page 32.

If you do not have a T-V LINK compatible VCR, press BLUE button to exit the menu.

If you have a T-V LINK compatible VCR connected to the Ext-2 terminal, press “**i**” button to display T-V LINK menu. Then follow the operating procedure “Downloading data to VCR” in the following T-V LINK section.

T-V LINK

When a T-V LINK compatible VCR connected to the EXT-2 terminal on the TV, it is easier to set up the VCR and to view videos. T-V LINK uses the following features:

To use T-V LINK functions

A “T-V LINK compatible VCR” means a JVC video cassette recorder with the T-V LINK logo, or with one of the following logos. For details see your VCR instruction manual.

“**Q-LINK**” (A trademark of Panasonic Corporation)

“**Data Logic**” (A trademark of Metz Corporation)

“**Easy Link**” (A trademark of Phillips Corporation)

“**Megalogic**” (A trademark of Grundig Corporation)

“**SMARTLINK**” (A trademark of Sony Corporation)

Downloading data to VCR:

The VCR will automatically download the registered data on the TV channels from the TV. This means you do not need to set up the programme channels on your VCR manually.

The “T-V LINK” menu will be displayed when you press the “**i**” button while PROGRAM menu is displayed.

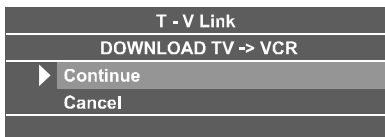

Press “▶” or “OK” button to start downloading data to VCR. “TRANSFER” is displayed in the menu.



Basic Operations

You can operate your TV both using the remote control and TV buttons.

Operation with the buttons on the TV

Volume Setting

- Press “▲ -” button to decrease volume or “▲ +” button to increase volume, so a volume level scale (slider) will be displayed at the middle of the bottom on the screen.

Programme Selection

- Press “P^” button to select the next programme or “Pv” button to select the previous programme.

Switching input mode

- Pressing TV/AV/OK button will change the input mode.

Entering Main Menu

- Press “MENU” button to enter Main menu. In the Main menu select submenu using “Pv” or “P^” button and enter the submenu using “▲ -” or “▲ +” button. Press TV/AV/OK button to enter. To learn the usage of the menus, refer to the Menu System sections.

Operation with Remote Control

The remote control of your TV is designed to control all the functions of the model you selected. The functions will be described in accordance with the menu system of your TV.

Functions of the menu system are described in following sections.

Volume Setting

Press “▲ +” button to increase volume. Press “▲ -” button to decrease volume. A volume level scale (slider) will be displayed in the middle at the bottom of the screen.



If you do not want to continue press the BLUE button to exit the menu.

If “FEATURE NOT AVAILABLE” is displayed, download was not performed correctly. Before trying to download again, check that:

- The VCR power is turned on.
- The VCR is T-V LINK compatible.
- The VCR is connected to the Ext-2.
- The scart cable is fully wired.

Direct REC:

You can easily record to VCR the images that you are watching on the TV. For details, read the manual for your VCR. Use your VCR controls you can not carry out Direct REC using your TV control.

When the VCR is not ready (For example when there is no tape inserted), “NO RECORDING” is displayed.

When you press the following buttons (Stand-by, **i**, AV, MENU, **≡**, SUBTITLE, GUIDE, **⏏**, TV/DTV) during recording, a message appears asking if you want to stop recording or not. Press **OK** button to stop recording or **BLUE** button to continue recording.

Do not turn the TV off in the following cases:

- When recording images from an external device connected to TV (For example camcorder).
- When recording a TV channel after it has been unscrambled on a decoder.
- When recording a TV channel by using the TV's output because the VCR's own tuner can not properly receive that channel.
- When recording Digital terrestrial broadcasting (DVB-T).

TV autpower on/VCR image view:

When the VCR starts playing, the TV automatically turns on and images from Ext-2 appear on the screen.

This function does not happen if your TV's main power is turned off. Set your TV's main power to on (StandBy Mode).

Programme Selection (Previous or next programme)

- Press “P∨” button to select the previous programme.
- Press “P∧” button to select the next programme.

Programme Selection (direct access):

Press digit buttons on the remote control to select programmes between 0 and 9. TV will switch to the selected programme. To select programmes between 10 - 99, press the digit buttons consecutively which programme you want to select (eg. for programme 27, first press 2 and then 7). When it is late to press second digit button only the first digit programme will be displayed. The limit of the delay time is 3 seconds.

Example: PR6 → press 6, PR12 → press 1 and 2.

Press directly the programme number to reselect single digit programmes.

Hint: The channel list numbers are assigned by the broadcasters. Because not all channels are broadcast free-to-air and stored by the receiver, the channel list numbers do not run continuously. The fifteenth channel in the list, for example, may not be channel number 15 but channel number 17.

Hint: If you enter a number which does not correspond to a stored channel, the next valid channel number is selected instead. If you enter a number greater than the highest numbered channel in the channel list, the IDTV will select the last channel in the list.

Operating while watching IDTV

Pressing the “TV/DTV” button at any time while watching television programmes will switch the TV set between displaying the digital terrestrial television broadcasting and its normal analogue broadcasting.

It is also used to switch to the last watched mode (TV or DIGITAL TV) from the EXT mode. For example; if a DVD player is connected with a SCART cable and powered on, then the IDTV will automatically switch to EXT mode. The IDTV will switch to the last watched mode (TV or DIGITAL TV) if DVD

player is switched off or “TV/DTV” button is pressed.

EVERYDAY OPERATION

While using the IDTV to the full, there are great many buttons to use in different situations. Many of the menu screens displayed by the IDTV have reminders as to which button do what, at the base of the screen. In addition, many screens have further help available which is displayed when the **i** button is pressed, as prompted at the bottom right of the screen.

OVER AIR DOWNLOAD

Over Air Download (OAD): To ensure that your IDTV always has the most up-to-date information. Please ensure that after use it is set to its standby mode. At 3AM each day, the IDTV automatically searches for any new information which may be broadcast and will download this to your IDTV automatically. This operation will normally take approximately 30 seconds.

If you want to do this, you need to set Automatic Download to “Enabled” in Receiver Upgrade setting. For details see page 23.

INFORMATION BANNER

Whenever you change channel, using the P∨ / P∧ buttons or the number buttons, an information banner is displayed at the bottom of the screen. This will remain on the screen for approximately three seconds. The information banner can also be displayed at any time while watching TV by pressing the **i** button on the remote control. Pressing the **i** button again removes the banner.

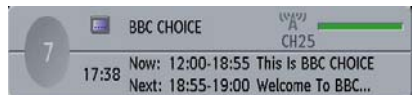

Hint: Not all channels broadcast the programme data. If the name and times of the programme is not available then “No Information” is displayed in the information banner.

The information banner gives a number of facts on the channel selected and the programmes on it. The name of the channel is displayed, along with its channel list number and an indication of the strength of the signal received on this tuning channel.

The name and the start and finish time of the programme currently showing on the selected channel are given, and the current time.

Icons are also displayed in the information banner and if this channel is a favourite channel.

favorite channel icon 😊

If the selected channel is locked, you must enter the correct four digit code to view the channel.

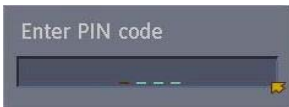

ELECTRONIC PROGRAMME GUIDE (EPG)

Another way of selecting a channel is with the electronic programme guide, or EPG. Like the Channel List, the EPG screen displays a list of the stored channels along with information on what programmes are being broadcast.

Using the Electronic Programme Guide

EPG can display 7 days programme guide, but in some areas only current and next programme guide is displayed.

By using EPG, you can select the channel and set the reminder for the programme which you do not want to miss.

To display the EPG screen, press the GUIDE button while watching Digital terrestrial broadcasting.

You can exit the EPG screen by pressing the GUIDE button again or the MENU button.

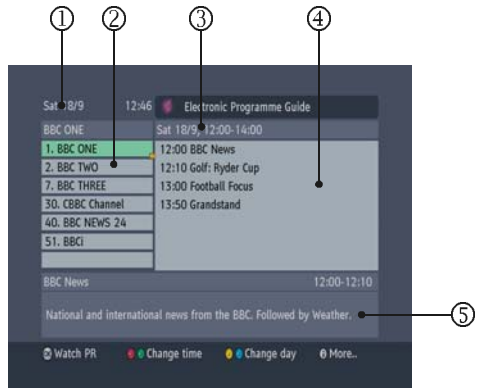

- ① Current date and time
 - ② Channel listings
 - ③ Selected date and time
 - ④ Programme name and broadcast time
 - ⑤ Brief description of the programme
- The programme name, broadcast time and a brief description of the programme are displayed for the programme chosen from the channel listings.

Choosing Channel

1. Press “▲” or “▼” buttons to choose the channel.

2. Press OK button.

The selected channel is displayed.

Programme Reminders

You can easily set the reminder so that you will not miss the programme you want to watch.

1. Press “▲” or “▼” buttons to choose the channel.

2. Press the Red and Green buttons to change the time and Yellow and Blue buttons to change the date.

3. Press “◀” or “▶” buttons and then “▲” or “▼” buttons to choose the programme you want to watch.

4. Press the OK button.

The reminder icon will be displayed on the right side of the chosen programme name and the setting is completed.

When the TV is being watched, it automatically changes to the channel of the reminded programme when the start time of the scheduled programme is reached.

- This function does not work when the TV is turned off.

To cancel the reminder setting

Display the EPG screen, choose a programme which has the reminder icon, and press the OK button.

Note:

- Reminder events are ignored if any timer event is active at that time.
- You can not set the reminder for the programme which has already started.
- “No Information” is displayed for the programme or channel which does not have any information. You can not set the reminder for these programmes.

DISPLAYING THE SUBTITLES

With Digital terrestrial broadcasting (DVB-T), some programmes are broadcast with subtitles. Subtitles can be displayed when watching these programmes.

- Press the **SUBTITLE** button when watching Digital terrestrial broadcasting (DVB-T).
“Subtitle ON” appears at the top-left of the screen and, if programme has subtitles, the subtitles are displayed.
- When the **SUBTITLE** button is pressed again, “Subtitle OFF” appears and the subtitles disappear.



Subtitle ON



Subtitle OFF

DIGITAL TELETEXT

With Digital terrestrial broadcasting (DVB-T), in addition to pictures and sound, you can also watch digital teletext.

Digital teletext is sometimes broadcast at the same time as normal broadcasting.

1. Press the button.

The digital teletext information appears.

2. Operate it with the colour buttons, buttons and OK button.

The operation method may differ depending on the contents of the digital teletext.

Follow the instructions displayed on digital teletext screen.

- When “Press SELECT” or similar message appears on the screen, press the **OK** button.

- When the  (Text) button is pressed, the TV returns to television broadcasting.

- With Digital terrestrial broadcasting (DVB-T), in addition to digital teletext broadcasting at the same time as normal broadcasting, there are also channels with just digital teletext broadcasting.

- The aspect ratio when watching a channel with just digital teletext broadcasting is the same as the aspect ratio of the picture watched previously.

- When you press the  (Text) button while subtitles are on, the subtitles are turned off.

When you press the  (Text) button again, the digital teletext screen is displayed.

DTV Menu

The DTV menu can only be shown when watching Digital terrestrial broadcasting. To display the DTV menu, do the following:

1. Press **MENU** button.

The menu appears.

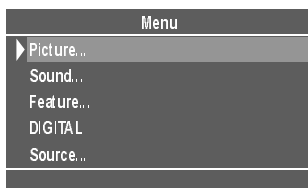

2. Choose **DIGITAL** and press the **OK** button.

The DTV menu appears.

DTV
Timers
Configuration
Edit PR List
Installation
Common Interface

Timers (DTV Timer Recording)

By setting the timer, you can record a Digital terrestrial broadcasting (DVB-T) programme with a VCR connected to Ext-2 while you are out.

- Before using DTV timer recording, the VCR and TV must be connected correctly. For details, see TV-LINK on page 15.
- When you have a T-V LINK compatible VCR connected to Ext-2, all you need to do is set the TV timer settings and the programme will be recorded.

By using “Direct Rec” of the T-V LINK function, the Direct Rec commands are sent from the TV to the VCR to automatically start and end the recording. It is not necessary to set the timer on the VCR.

- When your VCR is not T-V LINK compatible, you also need to set the VCR timer settings to match the TV timer settings.
- The recording may not start and stop at exactly the right times for some programmes. It is recommended that you allow some leeway when setting the recording times.
- Provided that the days and times are not the same, you can set up to ten timer settings.
- When subtitles are ON, the subtitles displayed with the broadcast will be recorded. When you do not want to record the subtitles, you need to turn OFF the subtitles settings beforehand (See “Displaying the subtitles” on Page19).
- During DTV timer recording, you are unable to view the DTV menu.

1. Choose Timers and press the OK button.

The REC TIMER menu appears.

No.	Name	Start	End	Date	Mode
1	BBC CHOICE	00:00	00:00	01/01/2004	Inactive
2	BBC ONE	00:00	00:00	01/01/2004	Inactive
3	BBC ONE	00:00	00:00	01/01/2004	Inactive
4	BBC ONE	00:00	00:00	01/01/2004	Inactive
5	BBC ONE	00:00	00:00	01/01/2004	Inactive
6	BBC ONE	00:00	00:00	01/01/2004	Inactive
7	BBC ONE	00:00	00:00	01/01/2004	Inactive
8	BBC ONE	00:00	00:00	01/01/2004	Inactive
9	BBC ONE	00:00	00:00	01/01/2004	Inactive
10	BBC ONE	00:00	00:00	01/01/2004	Inactive

- When the BACK button is pressed, the previous screen is returned to.

2. Press “▲” / “▼” buttons to choose the timer number, and then press the OK button.

The timer setting window appears.

No.	Name	Start	End	Date	Mode
1	BBC CHOICE	00:00	00:00	01/01/2004	Inactive
2	BBC ONE	00:00	00:00	01/01/2004	Inactive
3	BBC ONE	00:00	00:00	01/01/2004	Inactive
4	BBC ONE	00:00	00:00	01/01/2004	Inactive
5	BBC ONE	00:00	00:00	01/01/2004	Inactive
6	BBC ONE	00:00	00:00	01/01/2004	Inactive
7	BBC ONE	00:00	00:00	01/01/2004	Inactive
8	BBC ONE	00:00	00:00	01/01/2004	Inactive
9	BBC ONE	00:00	00:00	01/01/2004	Inactive
10	BBC ONE	00:00	00:00	01/01/2004	Inactive

Name	BBC CHOICE
Start	00:00
End	00:00
Date	01/01/2004
Mode	Once

3. Use the “▲” / “▼” buttons, number buttons and OK button to set the timer.

- When setting the start time and end time, input 1200 for 12:00 PM, 1500 for 3:00 PM and 0000 for 12:00 AM.

Name:

Use the “◀” / “▶” buttons to choose the channel for which the timer is to be set. Press the “▼” button.

Start:

Set the timer start time with the number buttons.

- When the “◀” / “▶” buttons are pressed, the

input position moves.

Press the “▼” button.

End:

Set the timer end time with the number buttons.

- When the “◀” / “▶” buttons are pressed, the input position moves.
Press the “▼” button.

Date:

Set the date for the timer to work with the numbers.

- When the “◀” / “▶” buttons are pressed, the input position moves.
Press the “▼” button.

Mode:

Use the “◀” / “▶” buttons to choose the timer mode (Once/Daily/Weekly), and then press the **OK** button.

4. Prepare your VCR for recording

When recording on a T-V LINK compatible VCR:

1. Insert the videotape for recording into the VCR and set the recording mode.
 2. Make sure the VCR is ready to receive Direct Rec commands from the TV.
 3. Make sure VCR timer settings do not coincide with the TV timer settings.
- For details, see your VCR instruction manual.

When recording on a T-V LINK incompatible VCR:

1. Insert the videotape for recording into the VCR and set the recording mode.
 2. Set the VCR recording timer settings.
 3. Make sure that the start and end time match with the TV timer.
 4. Set the VCR to record the signal from the external input that the TV is connected to.
- For details, see your VCR instruction manual.

When you have finished the step 4, you have set the timer.

When you are not watching TV, make sure the TV is in stand by.

WARNING :

Do not turn off the main power. The timer function will not work with the main power switched off.

The TV power lamp begins flashing before the timer start time. When you are watching TV at that time, a message appears on the screen to inform you the timer is about to start.

- When performing timer recording with a T-V LINK compatible device, test the timer recording before you record the programme. There are some T-V LINK compatible recording device that will not correctly receive the Direct Rec command from the TV.

If the recording device does not operate when the recording start time is reached, it means VCR is not receiving the Direct Rec command from the TV. In this case, follow the instructions of “When recording on a T-V LINK incompatible VCR:”.

While the timer is in operation:

- You can turn the TV on or off (Stand by).
WARNING: Do not turn off the main power.
- You can watch analogue terrestrial broadcasting channels or the pictures via an Ext terminal.
- Please note that any programme information that appears on the screen, such as when making changes to the Digital terrestrial broadcasting (DVB-T) channel picture, will be superimposed over the picture in the VCR recording.
- When you press the following buttons (i, AV, MENU, SUBTITLE, GUIDE,) during recording, a message appears asking if you want to stop recording or not. Press **OK** button to stop recording or **BLUE** button to continue recording.

Canceling the timer setting

Display the **REC TIMER** menu and press the “▲” / “▼” buttons to choose which timer setting to cancel. Press the “◀” / “▶” buttons so that “Inactive” appears in the Mode column.

Reactivating the cancelled timer setting

Display the **REC TIMER** menu and press the “▲” / “▼” buttons to choose which timer setting to reactivate. Press the “◀” / “▶” buttons so that “Active” appears in the Mode column.

Configuration

Set the basic setting when watching Digital terrestrial broadcasting (DVB-T).

Choose configuration and press the **OK** button.

CONFIGURATION appears.

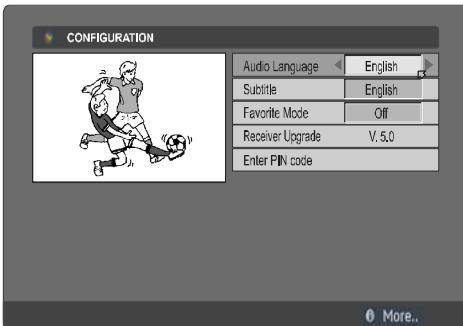

• When the **BACK** button is pressed, the previous screen is returned to. When **MENU** button is pressed, the menu appears.

• When the **i** (Information) button is pressed, the help screen appears. When it is pressed again, the previous screen is returned to.

Audio Language

With Digital terrestrial broadcasting (DVB-T), a number of languages can be broadcast at the same time. Choose language you want to listen when watching these broadcasts.

1. Press the “▲” / “▼” buttons and choose **Audio Language**.

2. Press the “◀” / “▶” buttons and choose the language.

Language changes every time the button is pressed.

• If the selected language is not broadcast, the default language will be played.

Subtitle Language

With Digital terrestrial broadcasting (DVB-T), a number of subtitles can be broadcast at the same time. Choose the subtitle you want to display when watching these broadcasts.

1. Press the “▲” / “▼” buttons and choose **Subtitle**.

2. Press the “◀” / “▶” buttons and choose a subtitle language that appears when the **SUBTITLE** button is pressed.

Favourite Mode

Enable/disable the **Edit PR List Favourites** settings.

1. Press the “▲” / “▼” buttons and choose **Favourite Mode**.

2. Press the “◀” / “▶” buttons and choose **ON** or **OFF**.

On:

The **Edit PR List Favourites** settings are enabled.

When the **P∨ / P∧** button is pressed, only the channels chosen in the **Edit PR List favourites** (those with the icon) can be chosen.

• For details on how to set your favourite channels, see “Setting the favourite channels” on page 25.

Off:

The **Edit PR List Favourites** settings are disabled.

When the **P∨ / P∧** button is pressed, all the channels registered in the **Edit PR List** can be chosen.

Receiver Upgrade

Set the method to upgrade the Digital terrestrial broadcast (DVB-T) receiver software.

1. Press the “▲” / “▼” buttons and choose Receiver Upgrade, and press the OK button. The setting window appears.

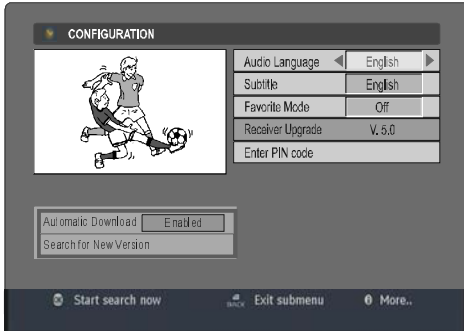

- The actual version may be different to the Receiver Upgrade version displayed above.
2. Press the “▲” / “▼” buttons and choose Automatic Download, and press the “◀” or “▶” buttons to choose Enable and Disable.

Enable (factory settings):

The Digital terrestrial broadcasting (DVB-T) software is automatically updated every day at 3:00 am. When enabled, the TV also searches for new software whenever it goes to standby.

Disable:

The Digital terrestrial broadcasting (DVB-T) software is not automatically updated.

Manually updating the Digital terrestrial broadcasting (DVB-T) information

Press the “▲” / “▼” buttons and choose Search for New Version, then press the OK button.

The Digital terrestrial broadcasting (DVB-T) information is updated.

In the future, there is a possibility that Receiver Update function may also be able to be used to update the Digital terrestrial

broadcasting (DVB-T) software and add new functions.

Enter PIN code

Choose Enter PIN code to change the PIN code for the Edit PR List menu's "Lock". The PIN code factory setting (how it is set when you purchase the television) is 0000.

1. Press the “▲” / “▼” buttons and choose Enter PIN code, and press the OK button.
2. Input the current PIN code.

When you are making this setting for the first time, input 0000.

When a PIN code has already been set, enter the correct PIN code.

The PIN code setting window appears.

3. Press the number buttons to input a new PIN code (password).
4. Input the new PIN code (password) again in the Confirm box.

“Pin code is changed” appears.

Your newly chosen PIN code is now set. You will now need to use the PIN code (password) you choose. Here to lock or to unlock the Edit PR List's "Lock".

Edit PR List

Choose Edit PR List and press the OK button.

EDIT PR LIST appears.

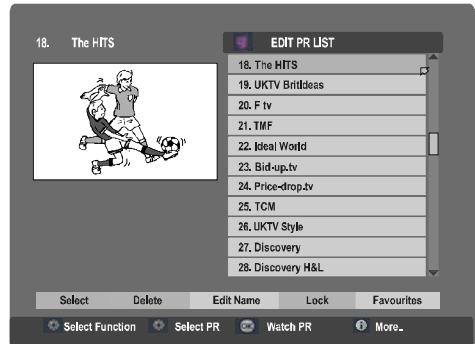

The Edit PR List can be used to do the following:

- delete registered channels

- edit channel names.
- lock channels so that they can not be watched by children.
- set Favourites so that you can easily choose from only the channels you often watch.
- Sometimes you may notice a drop in picture quality while watching your programme in the quarter-screen. This is not a fault.
- When the BACK button is pressed, the previous screen is returned to. When the TV/DTV or MENU button is pressed, the menu disappears.
- When the **i** (information) button is pressed, the help screen appears. When it is pressed again, the previous screen is returned to.

Here, you can preview any channel stored by the receiver before viewing it full screen. The complete list of channels is displayed in pages of 11 channels at a time, with their channel list number and a favourite channel icon if appropriate.

Choosing a channel

The chosen channel is shown on the quarter-screen.

1. Press the “◀” / “▶” buttons and choose Select on the bar at the bottom of the screen.
2. Press the “▲” / “▼” buttons and choose a channel, and then press the **OK** button.

The picture of the chosen channel is shown on the quarter-screen.

Deleting a channel

1. Press the “◀” / “▶” buttons and choose Delete on the bar at the bottom of the screen.
2. Press the “▲” / “▼” buttons and choose the channel to be deleted, and then press the **OK** button.

The channel deletion confirmation window appears.

3. Choose Yes and press the **OK** button.

The chosen channel is deleted.

- If you do not want to delete the chosen channel, choose NO and press the **OK** button.
- Perform “Installation” (see page 25) to re-register a channel that you have deleted.

Editing a channel name

1. Press the “◀” / “▶” buttons and choose Edit Name on the bar at the bottom of the screen.
2. Press the “▲” / “▼” buttons and choose the channel to be edited, and then press the **OK** button.
The EDIT window appears.
3. Press the “▲” / “▼” buttons and choose a character, press the “◀” / “▶” buttons to move the cursor and edit the name, and then press the **OK** button.

The edited channel appears in the Edit PR List.

Locking a channel

When there is a channel you do not want your children to watch, you can lock the channel.

1. Press the “◀” / “▶” buttons and choose Lock on the bar at the bottom of the screen.
2. Press the “▲” / “▼” buttons and choose the channel to be locked, and then press the **OK** button.

The Enter PIN code input window appears.

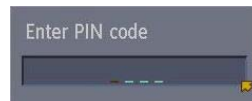

3. Press the number buttons to input to correct PIN code and press the **OK** button.

If you have not changed the PIN code in the CONFIGURATION menu's “Enter PIN Code” (see page 23), input the PIN code you chose.

The lock icon appears next to the channel name in the Edit PR List.

When a locked channel is chosen, the Enter PIN code input window will appear. If the correct PIN code is input, the picture appears.

- When you forget the PIN code for the “Lock”, you can unlock locked channels by performing Automatic Search (see INSTALLATION).

Setting the favourite channels

If only channels that you often watch are set as favourite channels, you can choose from just those channels by pressing **P**∨ / **P**∧.

- After setting the favourite channels, check the “Favourite Mode” in “Configuration” (see page 22) is set to ON.

1. Press the “◀” / “▶” buttons and choose Favourites on the bar at the bottom of the screen.
2. Press the “▲” / “▼” buttons and choose the channel to be registered as a favourite channel, and then press the **OK** button.

The favourite icon (😊) appears on the right side of the chosen channel.

When you leave the Channel List screen, by pressing “MENU” the channel showing on the quarter screen is selected for normal viewing on the whole screen.

Installation

Although your TV will not lose its settings or stored channels when switched off, you may wish to re-install the programs because you have moved to a different area with different broadcast frequencies, you wish to reinstate a channel previously deleted from the channel list, or you want to watch new channels which have started broadcasting.

Display the DTV Menu and using the “▲” or “▼” buttons, highlight the Installation line and press **OK** to display the Installation Menu.

The Installation menu appears.

You can either perform a First Time Installa-

tion, effectively resetting the receiver to its factory setting condition, or just search for channels.

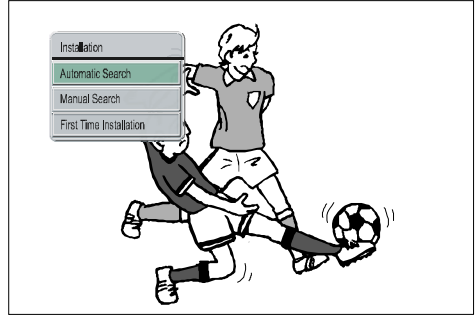

Automatic Search:

The receiver can search for channels automatically (searching all the broadcast frequencies for free-to-air channels).

To perform Automatic search, Select Automatic Search with the “▲” or “▼” buttons and press **OK**. A warning message is displayed.

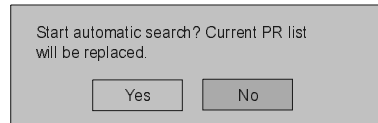

This starts the automatic tuning process and searches through all the available broadcast frequencies for free-to-air channels.



Previous channels will be replaced on automatic search.

Manual Search:

This is for searching for digital channels on a single broadcast frequency. The frequency channel number (21-68) is entered in the box at the top left of the screen and the received signal level and signal quality can be observed on the two bar graphs at the bottom. When **OK** is pressed, the TV searches that frequency and display a list of the channels found.

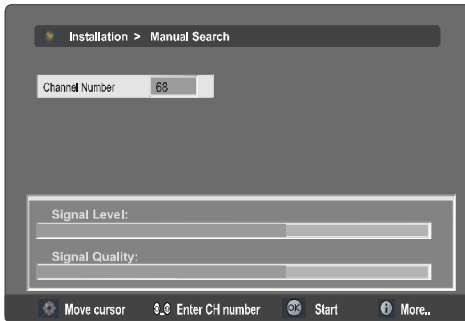

Hint

The bar graphs of signal quality and signal level give a good indication of whether any channels are likely to be found. If only the signal level graph shows a high value then it is likely that an analogue channel occupies that broadcast frequency. If the signal quality bar is high as well then it is a digital frequency and digital channels will probably be found.

Again, channels which duplicate those already in the channel list are ignored. However, the manual channel search will find all channels on the broadcast frequency.

When either search is finished, press the MENU key to return to normal digital broadcast viewing, to watch the new digital terrestrial television channels found.

First Time Installation:

To reset the TV, highlight the First Time Installation line in the menu and press **OK**. A warning screen is displayed in case of accidental operation.

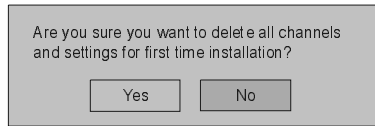

Highlight the YES button with the “◀” or “▶” key and press **OK** to erase all the channels and settings and switch the receiver to standby.

Common Interface

It is required to subscribe to a pay channel company to view the pay channels of the Digital Terrestrial broadcasting.

Obtain the Conditional Access Module (CAM) and the Viewing card by subscribing to a pay channel company, then insert those to the Television using the following procedure.

1. Switch off the TV and unplug from the mains.

2. Insert the CAM, then Viewing Card to the slot that is located in the terminal cover at the left-hand side of the TV (from front view).

- The CAM should be correctly inserted, it is impossible to insert fully if reversed. The CAM or the TV terminal may be damaged if the CAM is forcefully inserted.

3. Connect the TV to the mains supply, switch on and then wait for few moments until the card is activated.

- Some CAMs may require the following set up. Please set the CAM by entering the DTV menu, Common Interface then pressing **OK** button. (CAM set up menu is not displayed when it is not required.)

- To see the viewing contract information, press **MENU**, Select DTV and Press **OK**, then Select Common Interface and press **OK**.

- When no module is inserted, “**No CI Module**” appears.

- Refer to the module instruction manual for details of the settings.

Setting The TV

Menu System

Your TV's analogue part has been designed with a menu system to provide an easy manipulation of a multi-function system. The TV is controlled by choosing the commands, which are displayed on the screen.

MAIN MENU

Press the "MENU" button. The main menu will be displayed in the middle of the screen.



To select a sub-menu use "▲" or "▼" button, and press "◀" or "▶" button or directly press "OK" button.

In EXT-1, EXT-2 and EXT-4 modes, main menu appears the same as in TV mode but without Program sub-menu.

In EXT-3 mode, Main Menu appears as follows:



In DIGITAL TV mode, DIGITAL will appear on the Main menu. Install and Program do not appear.

Menu does not disappear automatically if it is left on the screen.

Press "MENU" button again to remove menu.

Picture Menu

Press "MENU" button, now you are in main menu. In the Main menu, select "Picture" using "▲" or "▼" button, then enter the Pic-

ture menu by pressing "◀" / "▶" or "OK" button.

Setting Mode

- As you enter the picture menu, Mode will be the first item.
- By pressing "◀" or "▶" button you may choose one of these options:
Soft, Standard and Bright.

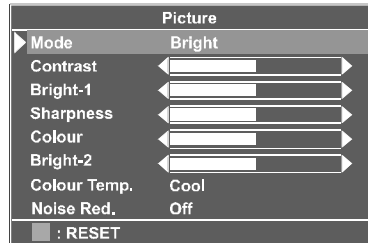

Setting Contrast

- Using "▲" or "▼" button select Contrast.
- Press "▶" button to increase contrast level.
- Press "◀" button to decrease contrast level.

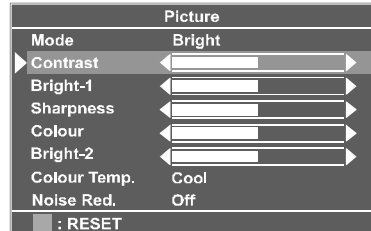

Setting Bright-1

- Using "▲" or "▼" button select Bright-1.
- Press "▶" button to increase brightness.
- Press "◀" button to decrease brightness.

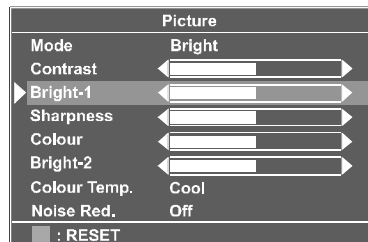

Setting Sharpness

- Using “▲” or “▼” button select Sharpness.
- Press “▶” button to increase sharpness level.
- Press “◀” button to decrease sharpness level.

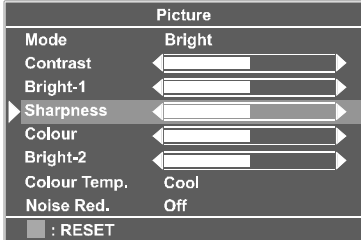

Setting Colour

- Using “▲” or “▼” button select Colour.
- Press “▶” button to increase colour level.
- Press “◀” button to decrease colour level.

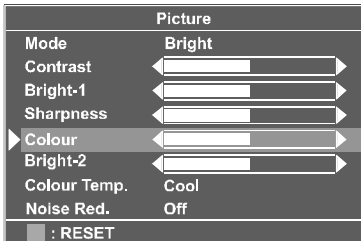

Setting Bright-2 (Only for 17D50BK)

Using “▲” or “▼” button select Bright-2.

- Press “▶” button to increase the back light.
- Press “◀” button to decrease the back light.

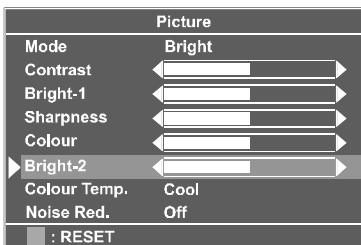

Setting Colour Temp.

- Using “▲” or “▼” button select Colour Temp.
- Press “◀” or “▶” button to select “Warm”, “Cool” or “Normal”.

Setting Noise Reduction

- Using “▲” or “▼” button select Noise Reduction.
- Press “◀” or “▶” button to select Noise Reduction level “Off” or “Minimum” or “Medium” or “Maximum”.

Note 1:

At low signal level, the changings on the Noise Reduction function are not effective when there is menu on the screen. If the menu is removed, the effect of this function is seen. At normal broadcasting, Noise Reduction changings are effective at once.

Note 2:

At moving pictures, while Noise Reduction is at maximum level, some picture distortions may occur. If Noise Reduction is set to medium or minimum, the picture will improve.

Setting Hue

During Playback NTSC system, this will appear in AV mode only when NTSC video source is applied. Otherwise, HUE option is invisible in Picture menu in TV mode :

- Using “▲” or “▼” button select Hue.
- Press “▶” button to increase hue level.
- Press “◀” button to decrease hue level.

Center value is indicated with one arrow.

Reset

Press BLUE button to reset the picture modes to factory default settings.

To Store the Settings

In the Picture Menu, all settings are stored automatically.

Sound Menu

As you enter the main menu, sound will be the second item. In the main menu, select **Sound** using “▲” or “▼” button, then enter the sound menu by pressing “◀” / “▶” or “OK” button.

Setting Volume:

As you enter the sound menu, Volume will be the first selected option.

- Press “▶” button to increase volume.
- Press “◀” button to decrease volume.

Or you can directly change the volume settings using “▲+” (to increase) or “-▶” (to decrease) button.

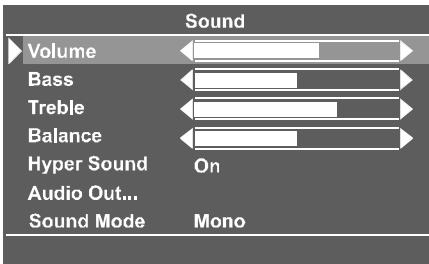

Setting Bass Level

- Using “▲” or “▼” button select Bass Level.
- Press “▶” button to increase bass level.
- Press “◀” button to decrease bass level.

Setting Treble Level

- Using “▲” or “▼” button select Treble
- Press “▶” button to increase treble level.
- Press “◀” button to decrease treble level

Setting Balance

It allows adjusting the distribution between the left and right speakers.

- Using “▲” or “▼” button select Balance.
- Press “▶” button to change balance rightward.
- Press “◀” button to change balance left-

ward.

Hyper Sound

- Using “▲” or “▼” button select Hyper Sound.
- Pressing “◀” or “▶” button will turn on or off this feature.

Pseudo/spatial effect can be turned on or off via the Hyper Sound item in the Sound menu or by remote control. In Mono transmission the left and right channels will be added at left channel and dummy stereo effect will be introduced to end-user.

In stereo transmission it yields a phase difference between left and right channels. Hyper Sound selection will be displayed on the screen when the TV Status button is pressed or programme is changed.

To Change Audio Out Settings

Audio Out is a sub-menu of Sound menu.

Use this settings to adjust volume for audio out terminal which is located at the right side of the TV.

- Using “▲” or “▼” button select Audio Out.
- Press “◀” or “▶” button or directly press “OK” button on **Audio Out**, to enter the Audio Out menu.



Audio Out Volume

- As you enter the Audio Out sound menu, Volume will be the only option.
- Press “▶” button to increase volume.
- Press “◀” button to decrease volume.

Selecting Sound Mode

- Using “▲” or “▼” button select Sound Mode.
- Press “◀” or “▶” button to change Sound Mode.

You can choose **Mono**, **Stereo** or **Dual (I-II)** mode, only if the selected channel supports that mode.

In case of bilingual broadcast (Dual Sound), you can select original or dubbed language using mode option. So when somebody listens to the original language from the loudspeakers, somebody else can listen to the dubbed language from headphone.

To Store The Settings

In the Sound Menu, all settings are stored automatically.

Feature Menu

Press “MENU” button, now you are in mainmenu. In the main menu, select **Feature** using “▲” or “▼” button. Then enter the Feature menu by pressing “◀” / “▶” or “OK” button.

Feature	
▶ Sleep Timer	Off
Child Lock	Off
Language	English
EXT-2 Output	TV
Blue Back	Off

Sleep Timer

The Sleep Timer is used to turn the TV off after a defined period of time after selecting this item. The timer can be programmed between Off and 120 minutes in steps of 10 minutes. (Off, 010, 020, 030, 040, ... , 120)

If sleep timer is activated, at the end of the selected time, the TV goes automatically to stand-by mode.

Child Lock

You can use this feature to prevent children turning on/off TV or changing programmes or adjustments etc. without remote control.

- Using “▲” or “▼” button select Child Lock.
- Press “◀” / “▶” button to select Child Lock On or Off.

The **Child Lock** feature can be set **On** or **Off** by “◀” / “▶” button. When **Off** is selected, there will be no difference in the operation of your TV. When **On** is selected, the TV can only be controlled by the remote control. In

this case the control panel buttons except “⏻” button on the right side of the TV will not work.

Selecting Menu Language

- Using “▲” or “▼” button select Language.
- Press “◀” or “▶” button to select menu language.

EXT-2 Output

From EXT-2 Output; TV, EXT-1, EXT-4 or DIGITAL can be given. These modes can be chosen by pressing “◀” or “▶” button on “EXT-2 OUTPUT”.

Feature	
Sleep Timer	Off
Child Lock	Off
Language	English
▶ EXT-2 Output	TV
Blue Back	Off

Blue Back (During No Signal)

The Blue Back Feature can be set by “▲” or “▼” button to either On or Off.

To Store Settings

In Feature menu all settings are stored automatically.

Install Menu

Press “MENU” button, now you are in main menu. In the main menu, select “Install” using “▲” or “▼” button. Then enter the Install menu by pressing “◀” / “▶” or “OK” button.

Install	
▶ Programme	P 02
Band	C
Channel	02
Colour System	Auto
Sound System	I
Fine Tunning	◀-----+-----▶
Search	048.25
Decoder(EXT-2)	Off
VCR	Off
Store	

In EXT mode, Install menu appears like this:

Install	
▶ Colour System	Auto
VCR	Off

You can change only Colour system and VCR.

Selecting Programme

- Using “▲” or “▼” button select Programme.
- To select programme number, you can use “◀” / “▶” button or Digit Buttons

Selecting Band

Band, can be chosen either,

- “C” or “S” by “◀” or “▶” button.

Selecting Channel

Channel can be changed by “◀” or “▶” button or by Digit Buttons.

Selecting Colour System

Using “◀” or “▶” button on **Colour System**, you can change the colour system to **PAL**, **SECAM** or **Auto**.

Note: In EXT mode, you can choose NTSC 3.58 and NTSC 4.43 as well.

Selecting Sound System

Using “◀” or “▶” button on **Sound System**, you can change the standard to **BG**, **DK**, **I**, **L**, **Lp**.

Selecting Fine Tuning

You can use the Fine Tuning process for fine adjustment (after coarse adjustment), if you are not happy about the image on the screen.

Use “◀” or “▶” button on **Fine Tuning** item, until getting the best image on the screen.

Selecting Search

To start the search process, press “▶” button for forward search or “◀” button for backward search. If a signal is found or reaches to end of the band after searching, press “◀” or “▶” buttons to continue search process. To stop the search process when you want, press “◀” or “▶” buttons at any time.

Decoder (EXT-2)

You can use this mode to connect any decoder to your TV.

- Press the “◀” or “▶” buttons to set it “On” or “Off”.

When you select Decoder (EXT-2) “On”, EXT-2 output will be chosen as TV mode only and any scrambled channels will be unscrambled through decoder connected your TV via EXT-2 output.

Setting VCR (Video Cassette Recorder) Mode

- This item can be seen in **TV**, **EXT-1**, **EXT-2**, **EXT-3** and **EXT-4** modes.
- If you want to watch a **VCR** source from one of these modes, then it will be better to set **VCR** mode “On”. For this, while the cursor is on this item press the “◀” or “▶” buttons to set it “On”.
- If you want to watch a **DVD**, then you must set this item “off”; because **DVD** is not a source like a **VCR** and to see the picture better, you must set the **VCR** mode “Off”.

To Store Settings

- Press “◀” / “▶” or “OK” button on **Store** option to store Install menu settings.
- After stored, T-V LINK menu will appear. If you do not need to do T-V LINK, press **BLUE** button to exit the menu.

Program Menu

Press "MENU" button, now you are in main menu. In the main menu, select "Program" using "▲" or "▼" button. Then enter the Programme menu by pressing "◀" / "▶" or "OK" button.

Note: There is no Program menu in any EXT modes.

Program		P01
▶01	BBC	11
02	RTL	12
03	XXXXX	13
04	_____	14
05	_____	15
06	_____	16
07	_____	17
08	_____	18
09	_____	19
10	_____	20
Name		Insert
Delete		Autostore
i : T-V Link		

Program Menu is used to delete a channel, to change the programme number of a channel, to give a channel name to a channel, and to start the A.P.S (Autostore) function.

To choose a channel in the PROGRAM menu

Press "▲" / "▼" / "◀" / "▶" button. The programme number that you choose is high-lighted in the Program.

Caution:

Using "Delete" or "Insert" function rewrite the current channel list in the Program menu. Therefore, the programme numbers of some of channels will change.

When you complete the settings of Program menu:

If you have a T-V LINK compatible VCR, press "i" button to display the T-V LINK menu. then follow the operating procedure "Downloading the data to VCR".

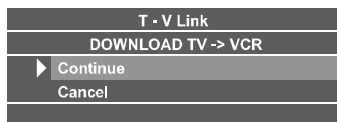

If you do not have a T-V LINK compatible VCR, press BLUE button to exit the menu.

To give a channel name (Name):

1. Choose the channel you want to give a channel name.
 2. Press the RED button to enter the Name mode.
 3. Press "◀" or "▶" button to choose the position, and press "▲" or "▼" button to choose each character of channel name.
 4. Press the RED button to store the channel name.
- To cancel the Name mode, press the BLUE button.

To delete a channel (Delete):

1. Choose the channel you want to delete.
 2. Press the YELLOW button to enter the Delete mode.
 3. Press the YELLOW button to delete it.
- To cancel the Delete mode, press the BLUE button.

To change the programme number of a channel (Insert)

1. Choose the channel you want to change the programme number.
2. Press the GREEN button to enter the Insert mode.
3. Press "▲" / "▼" / "◀" / "▶" button to choose new programme number.
4. Press the GREEN button to Insert the channel to the chosen programme number.

Autostore:

To enter Autostore menu, press the BLUE button. To learn the features of this function see "Autostore" below.

Autostore, searches and stores all channels automatically on your TV, according to the

transmission of programme systems in your area.



First of all choose the “**Country**” by using “◀” or “▶” button. Then press the Red button to start Autostore.

After Autostore is finalized, a programme list will appear on the screen. In the program list you will see the programme numbers and names assigned to the programmes.

If you do not accept the locations and/or the programme names of programmes, you can change them in Programme menu.

Source Menu

You can switch your TV to EXT modes by pressing directly to “**AV**” button or by selecting in source menu from the main menu.

While in EXT mode, you can also switch your TV to TV or other EXT modes by selecting in source menu from the main menu.

In main menu, firstly use “▲” or “▼” button then use “◀” / “▶” or “**OK**” button to enter Source menu. In source menu, move the cursor by “▲” or “▼” button and then press “**OK**” button or “◀” / “▶” buttons when the cursor is on the required item. The selected mode comes automatically on the screen.

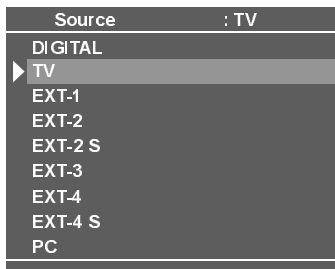

Other Features

TV Status

Programme Number, Programme Name (or **EXT**), (they are displayed on the upper left of the screen). The **sound indicator** is displayed with them too. They are displayed after programme change for 3 seconds.

Sound Indicator

The alternatives of the indicator are Mono, Stereo, Dual I and Dual II. This indicator is displayed under the programme number indicator on the screen.



In Mono broadcast or in forced-mono (for stereo broadcast).



In **Stereo** broadcast.



If dual broadcast detected. Dual I is selected in default and also can be selected after Dual II by Remote Control.



If Dual II selected by Remote Control.

Hyper Sound

By selecting Hyper Sound in sound menu or by pressing the “⊕⊖” button on your remote control, Pseudo/Spatial effect can be turned on or off. In Mono transmission the left and right channels will be added at left channel and dummy stereo effect will introduced to end-user.

In stereo transmission it yields a phase difference between left and right channels.

Mute Indicator

It is placed in the upper middle of the screen when enabled, and it stays there until it is disabled.



To cancel mute, there are two alternatives; the first one is by pressing the “⊕⊖” button,

this volume is set to the preceding value, and the second one is increasing the volume level.

No-Signal Detection (TV mode)

If no valid signal detected, it takes 5 minutes to switch to the Stand-By mode unless any signal detected or any Remote Control command is accessed.

After a Remote Control command (if No-Signal Timer is active) the timer stops and if no signal detected again the timer is initialized to 5 minutes and starts 3 seconds later again to count down.

It is not valid in EXT modes.

Volume Bar

It is displayed in the lower middle of the screen. When a volume command is received (pressing “▲ +” or “▲ -” by Remote Control or Control panel at the top of the TV) and no menu is active, it stays on the screen for 3 seconds, after the last volume command or until another command is received in between.



EXT Modes

By pressing the “AV” button you can switch your TV to EXT modes (except being in Teletext). Pressing this button will consecutively switch the TV in one of the optional EXT modes: **EXT-1**, **EXT-2**, **EXT-2 S**, **EXT-3**, **EXT-4**, **EXT-4 S** and **PC**.

In order to quit the EXT mode press any digit buttons or “P∨” or “P∧”

Zoom Modes

Zoom mode can be changed by pressing **Zoom** button. You can change the screen size according to the picture aspect ratio. Select the optimum one from the following **ZOOM** modes.

AUTO:

When a **WSS (Wide Screen Signalling)** signal, which shows the aspect ratio of the picture, is included in the broadcast signal or the signal from an external device, the TV automatically changes the **ZOOM** mode to **16:9 ZOOM** mode **PANORAMIC** or **FULL** mode according to the **WSS** signal.

- When the **AUTO** mode does not function correctly due to poor **WSS** signal quality or when you want to change the **ZOOM** mode, change to another **ZOOM** mode manually.

Using the different screen formats

Press the Red button to select the different modes: Auto, Full, Regular, Panoramic, 14:9 Zoom, 16:9 Zoom, 16:9 Zoom Subtitle modes.

Note: You can only choose **REGULAR** and **FULL** in **PC** mode.

FULL:

This uniformly stretches the left and right sides of a normal picture (4:3 aspect ratio) to fill the wide TV screen.

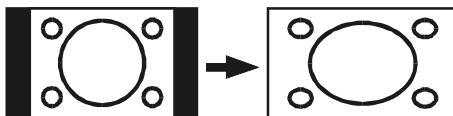

- For 16:9 aspect ratio pictures that have been squeezed into a normal picture (4:3 aspect ratio), use the **FULL** mode to restore the picture to its original shape.

REGULAR:

Use to view a normal picture (4:3 aspect ratio) as this is its original shape.



PANORAMIC:

This stretches the left and right sides of a normal picture (4:3 aspect ratio) to fill the screen, without making the picture appear unnatural.

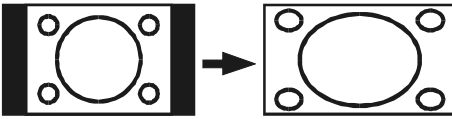

The top and bottom of the picture are slightly cut off.

14:9 ZOOM:

This zooms up the wide picture (14:9 aspect ratio) to the upper and lower limits of the screen.

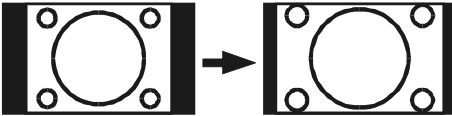

16:9 ZOOM:

This zooms up the wide picture (16:9 aspect ratio) to the full screen.

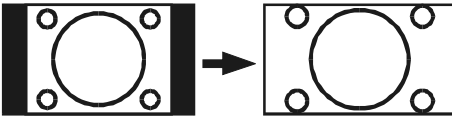

16:9 ZOOM SUBTITLE:

This zooms up the wide picture (16:9 aspect ratio) with subtitles to the full screen.

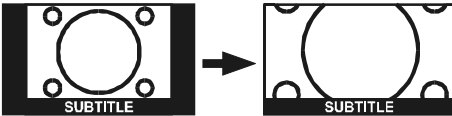

PC Mode

Installation

- Power off both Computer and the TV before making any connections.
- Set your PC's resolution correctly before connecting to the TV. See the table in page 44 or 45 for supported modes.
- Use a D-SUB cable to connect the TV's PC input to the computer's RGB output terminal. If you want to listen to the sound from the computer, use an audio cable to connect the PC AUDIO IN to the computer's sound output terminal.

15 Pin Mini D-Sub Connector

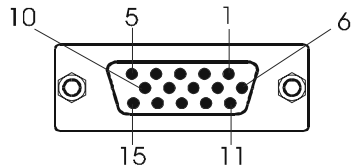

- Tighten the screws of the Display cable until the connectors are fastened securely (finger-tighten only).

Main Menu in PC mode:

Enter the main menu by pressing the "MENU" button on the remote control.

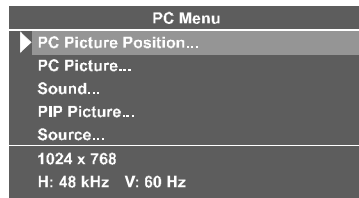

PC Picture Position Menu:

In the Main menu, select "PC Picture Position" using "▲" or "▼" button, then enter the menu by pressing "◀" / "▶" or "OK" buttons.

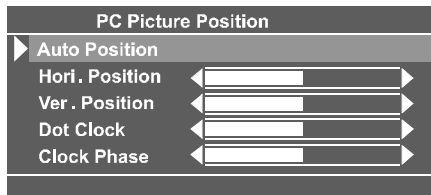

Auto Position

If you shift the picture horizontally or vertically to an unwanted position, use this item to put the picture into correct place automatically.

- Select Auto position item by using “▲” or “▼” buttons.
- Press “OK” button.
- Press “MENU” button or “BACK” button to store the value.

Warning: Auto position adjustment recommended to be done with the full screen image for the proper adjustment.

Horizontal Position

This item shifts the image horizontally to right hand side or left hand side of the screen.

- Select **Hor. Position** item by using “▲” or “▼” button.
- Use “◀” or “▶” button to adjust the value.
- Press “MENU” button or “BACK” button to store the value.

Vertical Position

This item shifts the image vertically towards the top or bottom of the screen.

- Select **Ver. Position** item by using “▲” or “▼” button.
- Use “◀” or “▶” button to adjust the value.
- Press “MENU” button or “BACK” button to store the value.

Dot Clock

Dot Clock adjustments correct interference that appear as vertical banding in dot intensive presentations like spreadsheets or text in smaller fonts.

- Use “◀” or “▶” button to adjust the value.

Clock Phase

Depending on the resolution and scan frequency that you input to the TV Set, you may see a muddy or noisy picture on the screen. In such a case you can use this item to get a clear picture by trial and error method.

- Use “◀” or “▶” button to adjust the value.

PC Picture Menu

In the Main menu, select “**PC Picture**” using “▲” or “▼” button, then enter the PC Picture menu by pressing “◀” / “▶” or “OK” buttons.

Contrast, Bright-1 and Colour Temperature adjustments in this menu are identical to adjustments defined in TV picture menu.

R, G, and B adjust the TV image colour in PC mode. You can change the TV colour to your desired colour: R (Red), G (Green), B (Blue)

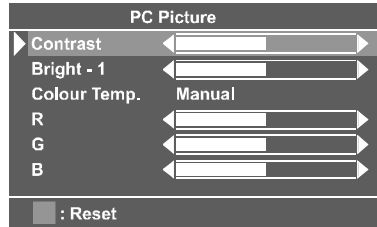

Sound Menu

In the main menu select “**Sound**” using “▲” or “▼” button then enter the Sound menu by pressing “◀” / “▶” or “OK” buttons.

The items in this menu are described at Sound menu starting **page 29**.

PIP Picture

In the Main menu, select “**PIP Picture**” using “▲” or “▼” button, then enter the PIP Picture menu by pressing “◀” / “▶” or “OK” buttons.

This menu is displayed when PIP is displayed on the screen. Otherwise “PIP No Signal” message will be displayed at the bottom of menu.



PIP picture is displayed on the screen by “” button.

Contrast, Bright-1, Colour and Sharpness are described at Picture menu on [page 27](#).

Setting PIP Size

- Using “▲” or “▼” button select PIP Size.
- Press “◀” or “▶” button to change PIP size. Two different PIP sizes are available.

Setting PIP Position

- Using “▲” or “▼” button select PIP Position.
- Press “◀” or “▶” button to change PIP position.

There are four different PIP positions.

Programme in the PIP window **can be changed** by “P∨ / P∧”, digit buttons or AV button. All EXT modes (Except EXT-3) are also available in PIP window. PIP window is removed from the screen by “⏻” button.

Source Menu

In the Main menu, select “**Source**” using “▲” or “▼” button, then enter the Source menu by pressing “◀” / “▶” or “OK” buttons.

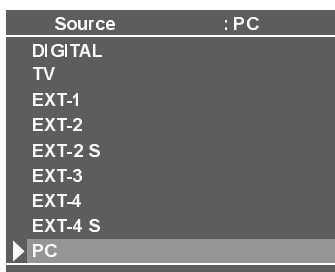

Select the available sources of **DIGITAL**, **TV**, **EXT-1**, **EXT-2**, **EXT-2 S**, **EXT-3**, **EXT-4**, **EXT-4S** or **PC** using “▲” or “▼” button and by pressing “◀” / “▶” or “OK” buttons.

Sound in PC mode

- Connect the PC's Audio output to the TV's **PC Audio In** socket with an audio cable.
- On your remote control, using “🎵” button to select sound source from **TV**, **EXT-1**, **EXT-2**, **EXT-3**, **EXT-4** and **PC** options.
- When PIP is displayed on the screen, “🎵”

button allows you to switch sound between PC and selected PIP source.

No-Signal and Out Of Range Detection (PC mode)

In PC Mode, as no menu is displayed, in case that there is no PC input to the TV, it is displayed an OSD message:

No input signal detected

then the power lamp turns to amber and PC will be in PC standby mode. Press AV button, digit buttons or “P∨” / “P∧” buttons to exit standby mode.

In PC Mode, as no menu is displayed, in case that there is no PC input to the TV, but the resolution and the vertical frequency is not supported by the concept, it is displayed an OSD message:

Signal out of range

Analogue Teletext

Teletext is an information system that displays text on your TV screen. Using the Teletext information system you can view a page of information on a subject that is available in the list of contents (index).

On screen display is not available in text mode.

Contrast, brightness or colour control is not available, but volume control is available in text mode.

To operate Teletext

- Select a TV station on which Teletext is being transmitted.
- Press (TELETEXT) “📄” button. Usually the list of contents (index) is displayed on the screen.



To select a page of Teletext

- Press the appropriate digit buttons for the required Teletext page number.

The selected page number is displayed at the top left corner of the screen. The Teletext page counter searches until the selected page number is located, so that the desired page is displayed on the screen.

- Press “**P**^” button to move the Teletext screen forward one page at a time.
- Press “**P**∨” button to move the Teletext screen backward one page at a time.

To Select Index Page

- To select the page number of the index (generally page 100), press “**i**” button.

Searching for a teletext page while watching TV

- In the Teletext mode pressing “**X**” button will switch the screen to the TV mode. In the TV mode enter a page number using digit buttons. As you enter last digit of page number, “**≡**” sign will replace the page number and flash until the entered page number is found. Then the page number will replace “**≡**” sign again. Now you can display this teletext page pressing “**X**” button.

To Select Double Height Text

- Press “**⇅**” button for the top half of the information page to be displayed in double height text.
- Press “**⇅**” button again for the bottom half of the information page to be displayed in double height text.
- Press “**⇅**” button once more for the full page of normal height text.

To Reveal “concealed” Information

- Pressing “**?**” button once will reveal answers on a quiz or games page.
- Pressing “**?**” button again will conceal the

revealed answers.

To Stop Automatic Page Change

The teletext page you have selected may contain more information than what is on the screen; the rest of the information will be displayed after a period of time.

- Press “**⏏**” button to stop the automatic page change.
- Press “**⏏**” button again to allow the next page to be displayed.

To Select a Subcode Page

Subcode pages are subsections of long Teletext pages that can only be displayed on the screen one section at a time.

- Select the required Teletext page.
- Press “**Ⓢ**” button.
- Select the required subcode page number by pressing four digit buttons (e.g. 0001).
- If the selected subcode page is not displayed in a short time, press “**X**” button. TV programme will be displayed on the screen.
- Teletext page number will be displayed on the upper left corner of the screen when the selected page is found.
- Press “**X**” button to display the selected Teletext page.

To exit Teletext

- Press “**≡**” button. The screen will switch to TV mode.

Fastext and Toptext

Your TV supports the 7 page Teletext system. When the page number of any of the 7 pages in memory is entered, the system will not search for the requested page; instead it will display the page automatically.

- Press “**P**^” button to move the Teletext screen forward one page at a time.
- Press “**P**∨” button to move the Teletext screen backward one page at a time.

For Fastext and Toptext

The subject-heading for the information may have a particular colour.

- Press an appropriate **RED**, **GREEN**, **YELLOW** or **BLUE** button in order to reach the relevant page quickly.

For TOPTTEXT

If Toptext transmission is present, colour coded buttons will appear in status row.

If Toptext transmission is not present, status row will not appear.

In Toptext mode the “**P**^” or “**P**∨” commands will request the next or previous page respectively. If Toptext transmission is not available, in case of operation of these commands, wraparound occurs. For example page 100 appears to be one greater than page 199.

Peripheral Equipment Connections

There is a wide range of audio and video equipment that can be connected to your TV.

Connection diagrams at the end of this section show you where the different equipment should be connected at the back side of the TV.

Via the Euroconnector

Your TV set has 2 Euroconnector sockets. If you want to connect peripherals (e.g. video, decoder, etc.) which have Euroconnectors, to your TV, use **EXT-1** or **EXT-2** input.

If an external device is connected via Euroconnector sockets TV is switched to AV mode automatically. In this case if both sockets are connected, **SCART1** has the precedence.

T-V LINK compatible VCR

Be sure to connect the T-V LINK compatible VCR to the **EXT.2** terminal. If not, the T-V LINK function will not work properly.

- When connecting a T-V LINK compatible VCR to the EXT.2 terminal, be sure to connect the decoder to the VCR. If not, the **T-V LINK** function may not work properly. And then set the **Decoder (EXT-2)** function for the channel to **ON** to unscramble a scrambled channel.

RGB mode

If an equipment can output the **RGB** signals, connect it to the **EXT-1** or **EXT-2** terminal.

EXT-2 S Mode

If the equipment connected to your TV set supports S-Video (Y/C) output from Euroconnector, you can have a better picture quality by selecting **EXT-2 S** mode and connecting your equipment to the **EXT.2 (EXT-2 S)** terminal of TV. See your equipment's booklet to check if your equipment has such feature.

Via the RCA jacks

If you have an equipment (such as a Camcorder) which has the RCA jacks, connect it to the **EXT-4** terminal with the video and audio cables.

If you have a device which outputs component signal, connect it to the **EXT-3** terminal with a component video cable.

Via the ANT (aerial) socket

If your equipment does not have an Euroconnector or RCA jacks, connect it to the TV with an aerial cable. For details, see the manual provided with the equipment.

- To store the test signal that comes from the equipment, see “**Install Menu**” on **page 30** and store it to the program number 0. You can watch images from that equipment to select the program number which you stored the test signal.

Decoder

Cable TV offers you a wide choice of programmes. Most of them are free, others are to be paid for by the viewer. This means that you will need to subscribe to the broadcasting organisation whose programmes you wish to receive. This organisation will supply you a corresponding decoder unit to allow the programmes to be unscrambled.

For further information ask your dealer. See also the booklet supplied with your decoder.

Connect a decoder with an aerial socket to the TV

- Connect the aerial cable.

Connect a decoder without an aerial socket to the TV

- Connect the decoder to your TV with a eurocable (RCA Jack Cable) to **EXTERNAL** (RCA Jack). When your decoder has a Euroconnector / RCA Jack you can obtain better picture quality if you connect a eurocable (RCA Jack Cable) to **EXTERNAL** (RCA Jack).

TV and Video Recorder (VCR)

- Connect the Video Recorder to the ANT (antenna input) socket of the TV with the aerial cable.
- Connect the Video Recorder to the **EXT-1** or **EXT-2** terminal with the SCART cable, or connect it to the **EXT-4** terminal with the audio and video cables.

NTSC Playback

Connect a NTSC video recorder to a terminal. Then press “**AV**” button to select the corresponding AV mode.

INTSC 3.58/4.43 system is detected automatically in AV mode.

Camera and Camcorder

To connect to the EXT-4 terminal

Connect your camera or camcorder at the back side of your TV.

- Connect your equipment to the TV via **VIDEO** (yellow), **AUDIO R** (red) and **AUDIO L** (white) inputs. You should connect the jacks to the input in the same colour.

Connect the decoder to the video recorder

Some video recorders have a special euroconnector for decoder.

- Connect a eurocable to the euroconnector of your decoder and to the special euroconnector of your video recorder. See also the handbook of your video recorder.
- To connect your video recorder to the TV, see TV and Video Recorder section.

If you want to connect more equipment to your TV, consult your dealer.

Connecting Headphones

Use the stereo headphone socket on the right side of your TV, to connect headphones.

Connecting the PC

Connect PC monitor with 15-pin PC cable to the 15-pin connector on the rear of the computer. For detail installation procedure see **Installation** in PC mode.

To connect to S-Video input

Connect your camera or camcorder at the back side of your TV.

- Connect your equipment to the TV via S-Video input at the back side by using S-Video cables.

Peripheral Equipment Connections

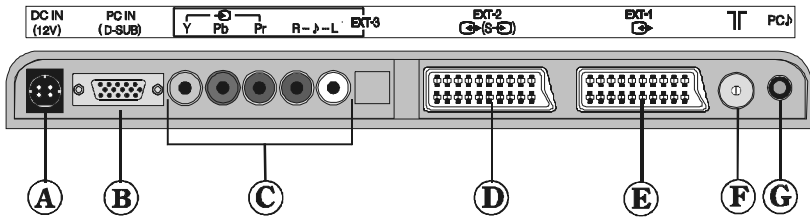
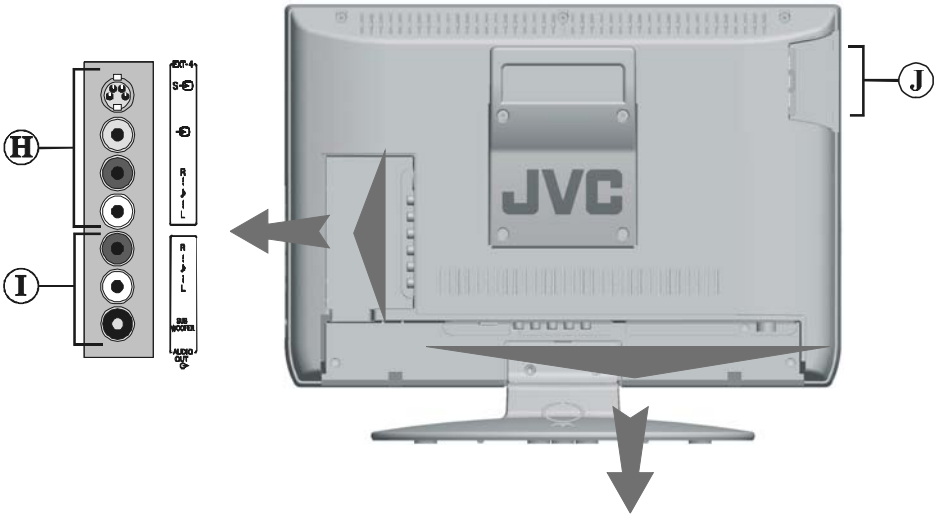

- Ⓐ DC IN
- Ⓑ PC INPUT
- Ⓒ EXT-3
 - Y
 - Pb
 - Pr
 - Component Audio In R
 - Component Audio In L
- Ⓓ EXT-2
- Ⓔ EXT-1
- Ⓕ ANTENNA
- Ⓖ PC AUDIO IN
- Ⓗ EXT-4
 - S-Video In
 - Video In
 - Audio R
 - Audio L
- Ⓘ OUT TERMINAL
 - Audio R
 - Audio L
 - Subwoofer Out
- ⓵ CARD SLOT

** The picture represents the rear view of Model 17D50BK. The connections for Model 23D50BK are identical.

Antenna Connections

Outdoor Antenna Connections

VHF antenna

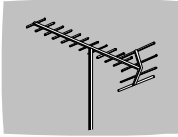

Round 75 ohm coaxial cable

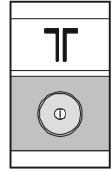

Rear of TV

VHF/UHF antenna

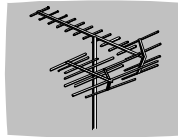

Flat 300-ohm twin lead cable

Round 75-ohm coaxial cable

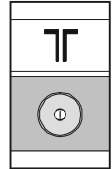

Rear of TV

Peripheral Equipment Connections

HEADPHONE



AUDIO

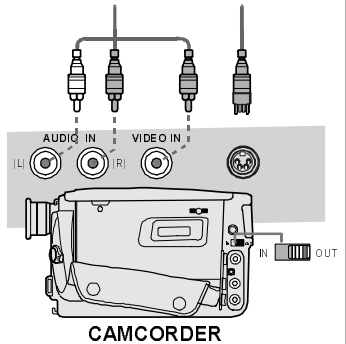
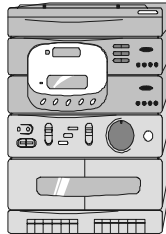

CAMCORDER

VIDEO

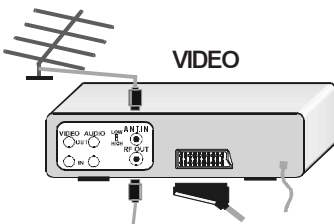

FOR SATELLITE RECEIVER

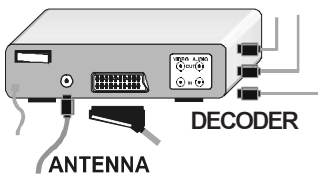

ANTENNA

DECODER

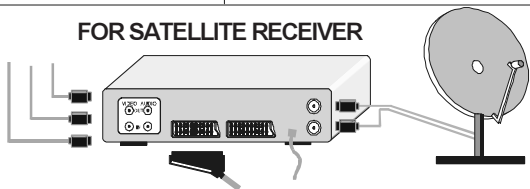

PC Input Typical Display Modes (Model: 17D50BK)

The display has a maximum resolution of 1280 x 768, vertical sync. frequency range of 50-75 Hz and a horizontal sync. frequency range of 30-69 KHz.

The following table is an illustration of some of the typical video display modes.

<i>Mode</i>	<i>Resolution</i>		<i>Frequency</i>	
	<i>Horizontal</i>	<i>Vertical</i>	<i>Hor. (kHz)</i>	<i>Ver. (Hz)</i>
1	640	400	31.5	60
2	640	400	31.5	70
3	640	480	31.5	60
4	640	480	37.9	72
5	640	480	37.5	75
6	720	400	31.5	70
7	800	600	35.2	56
8	800	600	37.9	60
9	800	600	48.1	72
10	800	600	46.9	75
11	1024	768	48.4	60
12	1024	768	56.5	70
13	1024	768	60.0	75
14	1280	720	44.6	60
15	1280	768	47.6	60

The native resolution of the TFT-LCD Panel is 1280 x 768. Therefore using Mode 15 is advised to get the best PC input display quality.

PC Input Typical Display Modes (Model: 23D50BK)

The display has a maximum resolution of 1360 x 768, vertical sync. frequency range of 50-75 Hz and a horizontal sync. frequency range of 30-69 KHz.

The following table is an illustration of some of the typical video display modes.

<i>Mode</i>	<i>Resolution</i>		<i>Frequency</i>	
	<i>Horizontal</i>	<i>Vertical</i>	<i>Hor. (kHz)</i>	<i>Ver. (Hz)</i>
1	640	400	31.5	60
2	640	400	31.5	70
3	640	480	31.5	60
4	640	480	37.9	72
5	640	480	37.5	75
6	720	400	31.5	70
7	800	600	35.2	56
8	800	600	37.9	60
9	800	600	48.1	72
10	800	600	46.9	75
11	1024	768	48.4	60
12	1024	768	56.5	70
13	1024	768	60.0	75
14	1280	720	44.6	60
15	1360	768	47.7	60

The native resolution of the TFT-LCD Panel is 1360 x 768. Therefore using Mode 15 is advised to get the best PC input display quality.

Tips

Can not turn the TV on?

Check that TV/VCR/DVD switch is set to TV position.

TV may go to stand-by mode when you turn the TV on soon after you turn the TV off. If you can turn the TV on again, it is not a problem.

Can not turn the TV off?

Check that TV/VCR/DVD switch is set to TV position.

Care of the Screen

Clean the screen with a slightly damp, soft cloth. Do not use abrasive solvents as they may damage the TV screen coating layer.

Colours of image on screen are abnormal

Have you selected the correct TV system? Is your TV set or house aerial located too close to the loudspeakers, non-earthed audio equipment or neon lights, etc. ?

Mountains or high buildings can cause double pictures or ghost images. Sometimes you can improve the picture quality by changing the direction of the aerial.

Is the picture or Teletext unrecognisable? Check if you have entered the correct frequency.

The picture quality may degrade when two peripherals are connected to the TV at the same time. In such a case, disconnect one of the peripherals.

No Image on Display Screen

Is the aerial connected properly? Are the plugs connected tightly to the aerial socket? Is the aerial cable damaged? Are suitable plugs used to connect the aerial? If you are in doubt, consult your dealer.

No Image means that your TV is not receiving any transmission. Have you pressed the correct buttons on the remote control? Try once more.

PC Picture

If no PC picture appears, check that the D-SUB cable is connected properly. Check that your PC's resolution set correctly. See **pages 44-45** for supported modes.

Sound

You can not hear any sound. Did you perhaps interrupt the sound, pressing "MUTE" button? Are external speakers connected to the TV?

Sound is coming from only one of the speakers. Is the balance set to one direction extreme? See **Sound** menu.

Remote Control

If your TV no longer responds to the remote control, perhaps the batteries are exhausted. Replace the batteries.

Have you selected the wrong menu? Press **MENU** button to return to normal screen or press **"BACK"** button to return to the previous menu.

No solution

If the TV suddenly stops responding, disconnect the power cord of the TV from the AC outlet. Connect them to the AC outlet again to turn on the TV. If the TV returns to a normal state, it is not a failure. If this does not work, switch off, remove the mains plug and call the service personnel; never attempt to repair it yourself.

Bad picture (in digital mode)

Although this TV can receive both Digital terrestrial broadcasting (DVB-T) and Analogue terrestrial broadcasting, you may not be able to receive DVB-T depending on the area in which you live.

If the picture freezes a lot, or block effect is seen frequently on screen, probably there is a problem with your reception.

Please contact customer services of your service provider if you are a subscriber.

Specifications

Item	Model	LT-17D50BK
Broadcasting Systems		PAL BG, DK, I
Channels and Frequencies		Digital : 474 MHz - 858 MHz Analogue : 46.25 MHz - 862.25 MHz Cable TV (S1-S20/ S21-S41)
Input Signal		Video: Analog 0,7 Vp-p 75 ohm positive Sync: TTL Level positive or negative, Seperate sync.
Horizontal Timing		30 - 69 KHz
Vertical Timing		50 - 75 KHz
Dot Rate		78,75 MHz max.
Panel Size		17,01" (433 mm) (measured diagonally)
Visible Picture Size		371,7 mm horizontal x 223.5 mm vertical
Display Resolution		1280 x 768 max. (WXGA)
Number of Preset Channels		100
Channel Indicator		On Screen Display (OSD)
RF Aerial Output		75 Ohm (unbalanced)
Power Requirements		Adaptor: 100-240 V AC, 50 Hz / TV: 12 V DC
Power Consumption (W)		59 W (max) / STAND-BY <3W
Sound Systems		German , Nicam Stereo
Audio Output		2 x 5 W _{RMS} (%10 THD)
EXT-1 Terminal		Euroconnector (21-pin, SCART) (bottom of the TV) <ul style="list-style-type: none"> • Video Input, Audio L/R Inputs and RGB inputs are available. • TV broadcast outputs (Video and Audio L/R) are available.
EXT-2 Terminal		Euroconnector (21-pin, SCART) (bottom of the TV) <ul style="list-style-type: none"> • Video Input, S-VIDEO (Y/C) input, Audio L/R and RGB inputs are available. • Video and Audio L/R outputs are available. • T-V LINK functions are available.
EXT-3 Terminal		RCA connectors x 5 (bottom of the cabinet) <ul style="list-style-type: none"> • Component video (Pr, Pb, Y) inputs and Audio L-R inputs are available • 576p (625p) and 480p (525p) signals are available.
EXT-4 Terminal		RCA connectors x 3 (side of the cabinet) S-VIDEO connector x 1 (side of the cabinet) <ul style="list-style-type: none"> • Video input, S-VIDEO (Y/C) input and Audio L/R inputs are available.
AUDIO OUT Terminal		RCA connectors x 3 <ul style="list-style-type: none"> • Audio L/R output are available. • Subwoofer out is available.
PC IN terminal		Analog RGB D-SUB 15 x 1 <ul style="list-style-type: none"> • PC signal is available (refer to page 44 for details of the signals which can be input)
PC AUDIO IN terminal		Stereo mini-jack (3.5 mm diameter)
Card Slot		Card Slot for the Conditional Access Module (CAM) x1
Dimensions (W x H x D)		465 mm x 370 mm x 200 mm 465 mm x 326 mm x 72 mm (TV only)
Weight		6,0 kg (with stand) / 5,0 kg (TV only)
Accessories		Remote control unit x 1 (RM-1895) / AA/R6 dry cell battery x 2 AC adapter x 1 Power cord x 1
Headphone jack		Stereo mini-jack (3.5 mm diameter)

Specifications

Item	Model	LT-23D50BK
Broadcasting Systems		PAL BG, DK, I
Channels and Frequencies		Digital : 474 MHz - 858 MHz Analogue : 46.25 MHz - 862.25 MHz Cable TV (S1-S20/ S21-S41)
Input Signal		Video: Analog 0,7 Vp-p 75 ohm positive Sync: TTL Level positive or negative, Seperate sync.
Horizontal Timing		30 - 69 KHz
Vertical Timing		50 - 75 KHz
Dot Rate		78,75 MHz max.
Panel Size		23,01" (583,1 mm) (measured diagonally)
Visible Picture Size		508,5 mm horizontal x 286,1 mm vertical
Display Resolution		1360 x 768 max. (WXGA)
Number of Preset Channels		100
Channel Indicator		On Screen Display (OSD)
RF Aerial Output		75 Ohm (unbalanced)
Power Requirements		Adaptor: 100-240 V AC, 50 Hz / TV: 24 V DC
Power Consumption (W)		110 W (max) / STAND-BY <3W
Sound Systems		German , Nicam Stereo
Audio Output		2 x 5 W _{RMS} (%10 THD)
EXT-1 Terminal		Euroconnector (21-pin, SCART) (bottom of the TV) <ul style="list-style-type: none"> • Video Input, Audio L/R Inputs and RGB inputs are available. • TV broadcast outputs (Video and Audio L/R) are available.
EXT-2 Terminal		Euroconnector (21-pin, SCART) (bottom of the TV) <ul style="list-style-type: none"> • Video Input, S-VIDEO (Y/C) input, Audio L/R and RGB inputs are available. • Video and Audio L/R outputs are available. • T-V LINK functions are available.
EXT-3 Terminal		RCA connectors x 5 (bottom of the cabinet) <ul style="list-style-type: none"> • Component video (Pr, Pb, Y) inputs and Audio L-R inputs are available • 576p (625p) and 480p (525p) signals are available.
EXT-4 Terminal		RCA connectors x 3 (side of the cabinet) S-VIDEO connector x 1 (side of the cabinet) <ul style="list-style-type: none"> • Video input, S-VIDEO (Y/C) input and Audio L/R inputs are available.
AUDIO OUT Terminal		RCA connectors x 3 <ul style="list-style-type: none"> • Audio L/R output are available. • Subwoofer out is available.
PC IN terminal		Analog RGB D-SUB 15 x 1 <ul style="list-style-type: none"> • PC signal is available (refer to page 45 for details of the signals which can be input)
PC AUDIO IN terminal		Stereo mini-jack (3.5 mm diameter)
Card Slot		Card Slot for the Conditional Access Module (CAM) x1
Dimensions (W x H x D)		614 mm x 482 mm x 240 mm 614 mm x 438 mm x 79 mm (TV only)
Weight		7,4 kg (with stand) / 6,4 kg (TV only)
Accessories		Remote control unit x 1 (RM-1895) / AA/R6 dry cell battery x 2 AC adapter x 1 Power cord x 1
Headphone jack		Stereo mini-jack (3.5 mm diameter)

Corrections

The following corrections are made on the related pages.

Page 25:

“You can either perform a First Time Installation, effectively resetting the receiver to its factory setting condition, or just search for channels.”

should be:

“You can either select Factory Settings, effectively resetting the receiver to its factory setting condition, or just search for channels.”

Page 25:

Installation menu picture should be:

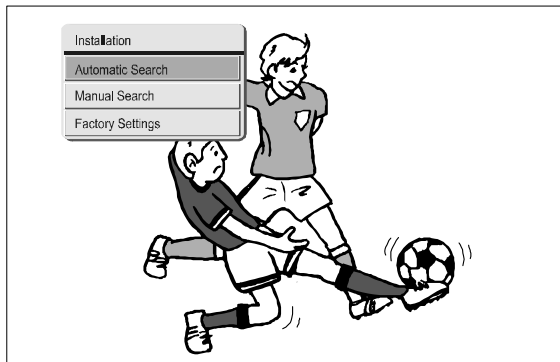

Page 26:

“First Time Installation:

To reset the TV, highlight the First Time Installation line in the menu and press **OK**. A warning screen is displayed in case of accidental operation.

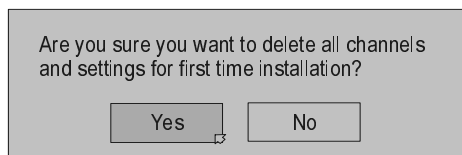

Highlight the YES button with the “◀” or “▶” key and press **OK** to erase all the channels and settings and switch the receiver to standby.”

should be:

“Factory settings:

To reset the TV, highlight the Factory Settings line in the menu and press **OK**. A warning screen is displayed in case of accidental operation.

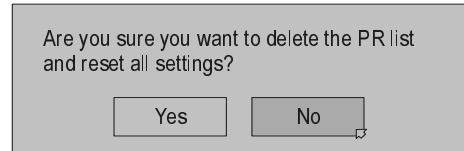

Highlight the YES button with the “◀” or “▶” key and press **OK** to erase all the channels and settings. A message will be displayed on the screen.

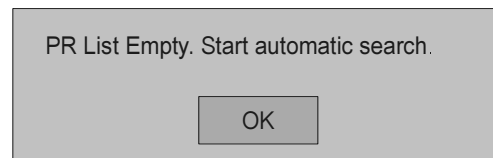

• Press the **OK** button to start the automatic search.

• When the automatic search has finished, the EDIT PR LIST menu appears.”